

Ruch poprzez technikę



Arnold & Stolzenberg GmbH
Firma należąca do grupy RENOLD
Postfach 16 35 und 16 45
37574 Einbeck-Juliusmühle
Tel. 0 55 62 / 81 - 248
Fax 0 55 62 / 81 - 130
Email: info@arnold-und-stolzenberg.de
www.arnold-und-stolzenberg.de

Arnold & Stolzenberg GmbH
Wichmannstraße 4
22607 Hamburg
Tel. 0 40 / 8 99 23 10
Fax 0 40 / 8 90 76 97

Arnold & Stolzenberg GmbH
Lerchenstraße 68 a
33607 Bielefeld
Tel. 05 21 / 29 00 63
Fax 05 21 / 29 09 62

Arnold & Stolzenberg GmbH
Liststraße 50
40470 Düsseldorf
Tel. 02 11 / 62 29 29
Fax 02 11 / 61 59 51

Arnold & Stolzenberg GmbH
Fr.-Wilh.-von-Steuben-Straße 104
60488 Frankfurt
Tel. 0 69 / 78 69 99
Fax 0 69 / 7 89 30 16

Arnold & Stolzenberg GmbH
Enzstraße 34
70806 Kornwestheim
Tel. 0 71 54 / 2 15 87
Fax 0 71 54 / 1 69 90



Autoryzowane punkty sprzedaży



Zakres produkcji

Arnold & Stolzenberg GmbH

Firma należąca do grupy RENOLD

łańcuchy rolkowe





Arnold & Stolzenberg GmbH

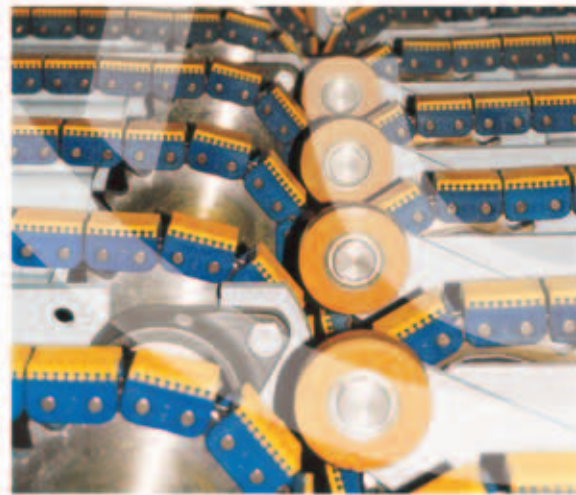

Spis treści

Technika w skrócie 4-7

Łańcuchy napędowe 8-15

DIN 8187, część 1, Standard europejski	8
- łańcuchy jednorzędowe	
- łańcuchy dwurzędowe	
- łańcuchy trzyczędowe	
DIN 8188, część 1, Standard amerykański	10
- łańcuchy jednorzędowe	
- łańcuchy dwurzędowe	
- łańcuchy trzyczędowe	
Łańcuchy niewymagające konserwacji „Syno/Sovereign“	12
Łańcuchy ze stali nierdzewnej „Coris“	13
Łańcuchy rolkowe wg. normy zakładowej	14
Łańcuchy o podwójnej podziałce DIN 8181	15

Łańcuchy do celów transportowych 16-35

DIN 8187, część 2 w DIN 8188, część 2	16
- zabieraki w wykonaniu M1 i M2	
- zabieraki w wykonaniu K1 i K2	
DIN 8187, część 3 w DIN 8188, część 3	24
- łańcuchy rolkowe z przedłużonymi sworzniami	
Łańcuchy z nakładką typu U	25
Łańcuchy z nakładką polimerową - 2K	26
Łańcuchy z nakładką polimerową	28
Łańcuchy z pustymi sworzniami	32
Łańcuchy do pracy po łuku	33
Łańcuchy akumulacyjne /transferowe	34

Łańcuchy do podnoszenia 36-37

Łańcuchy Flayera	36
- Typ ciężki LH	
- Typ lekki LL	
- Typ AL	
- Norma zakładowa	

Powierzchnia przegubów, max. obciążenie rolek 38



łańcuchy oznaczone tym znakiem mogą być napędzane kołami łańcuchowymi według norm DIN/ISO tak jak to jest określone w odpowiednich tabelach.



Norma zakładowa



Łańcuch wg normy DIN europejskiej



Łańcuch wg normy DIN amerykańskiej





Technika w skrócie

Przekonajcie się Sami!





Łańcuchy niewymagające konserwacji	Wykonanie	Konstrukcja	Zastosowania	Przygotowanie powierzchni
	<ul style="list-style-type: none"> - Syno - Sovereign 	<p>Syno</p> <ul style="list-style-type: none"> - impregnowane olejem tulejki dające efekt samosmarowania - standardowo zastosowany jest smar dopuszczony do kontaktu z żywnością - specjalne sworznie ze stali spiekanej - rolki wyciskane na zimno - siła zrywająca wg norm DIN 8187/8188, ISO 606 <p>Sovereign</p> <ul style="list-style-type: none"> - trudnościeralne bolce z regenerującą się powierzchnią - tulejki i rolki wyciskane na zimno - siła zrywająca wg norm DIN 8187/8188 	<p>Syno</p> <ul style="list-style-type: none"> - gdzie tradycyjne smarowanie jest niewygodne do przeprowadzenia lub niemożliwe <p>Sovereign</p> <ul style="list-style-type: none"> - gdzie łańcuchy narażone są na pracę z dużymi prędkościami i jednocześnie przenoszą duże siły - gdy wymagana jest praca w stanie awaryjnym, w ciężkich warunkach otoczenia 	<p>Syno</p> <ul style="list-style-type: none"> - standardowo smarowane smarem o długim działaniu dopuszczonym do kontaktu z żywnością <p>Sovereign</p> <ul style="list-style-type: none"> - wolny wybór smarów

str. 12

Łańcuchy rolkowe	Wykonanie	Konstrukcja	Zastosowania	Przygotowanie powierzchni
	<ul style="list-style-type: none">  Typ europejski DIN 8187 część 1, ISO 606  Typ amerykański DIN 8188 część 1, ISO 606  A&S-Norma zakładowa <p>Z magazynu: jednorzędowe, dwurzędowe, trzyrzędowe, wielorzędowe</p>	<ul style="list-style-type: none"> - rolki wyciskane na zimno - napinany wstępnie min 1/3 gwarantowanej siły zrywającej 	<p>Przykłady</p> <ul style="list-style-type: none"> - budowa maszyn i urządzeń - technika transportowa - rolnictwo - maszyny drukarskie - maszyny do pakowania - specyficzne zastosowania klienta 	<ul style="list-style-type: none"> - smarowany/na sucho - galwanicznie chromowany na żółto (SZ) - galwanicznie chromowany na niebiesko (VZ) - niklowany galwanicznie (VN) - niklowany chemicznie (VNc) - stal nierdzewna (SS)

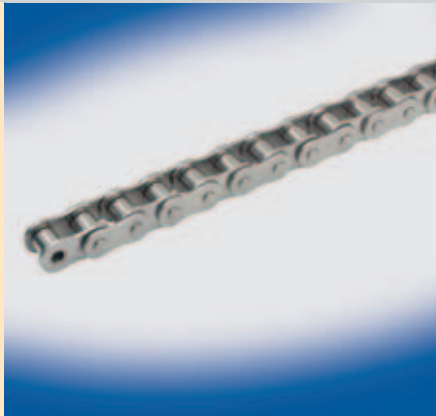
str. 8-11

Łańcuchy ze stali nierdzewnej „Coris“	Wykonanie	Konstrukcja	Zastosowania	Przygotowanie powierzchni
	<ul style="list-style-type: none">  Typ europejski DIN 8187 część 1, ISO 606  Typ amerykański DIN 8188 część 1, ISO 606 <p>Z magazynu: jednorzędowe, dwurzędowe, trzyrzędowe, wielorzędowe</p>	<ul style="list-style-type: none"> - rolki wyciskane - odporność na działanie ługów - odporność na działanie wody - odporność na działanie gorącej pary wodnej - odporność na działanie kwasów - odporność na niskie temperatury do -40 °C - odporność na wysokie temperatury do + 400 °C - możliwość wykonania z zabierakami 	<p>Zastosowanie w środowisku korozyjnym</p> <ul style="list-style-type: none"> - przemysł spożywczy - przemysł tekstylny - pralnie chemiczne - przemysł chemiczny - oczyszczalnie ścieków - przemysł chłodniczy 	<ul style="list-style-type: none"> - na sucho / smarowane

str. 13

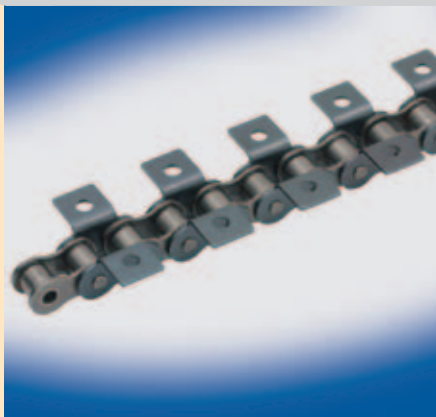
Łańcuchy rolkowe z zabierakami	Wykonanie	Konstrukcja	Zastosowania	Przygotowanie powierzchni
	<ul style="list-style-type: none"> - z zabierakami: typ M1 i M2 - z zabierakami kątowymi: typ K1 i K2 - z przedłużanymi sworzniami - z zabierakami typu U - możliwość mocowania wielu elementów specjalnych 		<ul style="list-style-type: none"> - technika transportowa - maszyny rolnicze - maszyny do pakowania - technika składowania - przemysł spożywczy 	<ul style="list-style-type: none"> - sucho - galwanicznie chromowany na żółto (SZ) - galwanicznie chromowany na niebiesko (VZ) - niklowany galwanicznie (VN) - niklowany chemicznie (VNc) - stal nierdzewna (SS)

str. 16-25

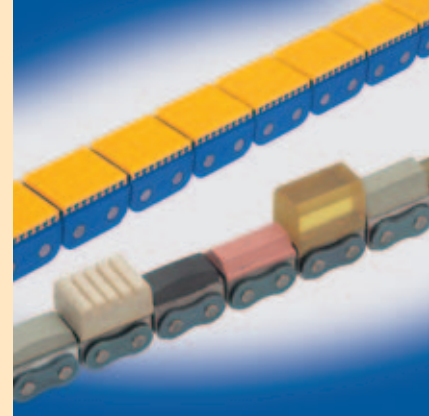
Łańcuchy z nakładką polimerową	Wykonanie	Konstrukcja	Zastosowania	Przygotowanie powierzchni
	<p>2K- Łańcuchy z nakładkami polimerowymi</p> <ul style="list-style-type: none"> - łańcuch wg norm DIN 8187/8188, ISO 606 - nakładka: Poliuretan 1/2" do 1" jednorzędowe, 1/2" dwurzędowe <p>Łańcuchy z nakładkami polimerowymi</p> <ul style="list-style-type: none"> - łańcuch wg norm DIN 8187/8188, ISO 606 - podziałka Od 1/2" do 1 1/2" - 36 profili standardowych - nakładka: NR, NBR, PUR 	<p>2K- Łańcuchy z nakładkami polimerowymi</p> <ul style="list-style-type: none"> - bardzo stabilne mocowanie nakładek - odporność na ługi, oleje i tłuszcze - duża odporność na zrywanie - wymienne profile - łatwo wymienne nakładki - bez silikonu <p>Elastomery</p> <ul style="list-style-type: none"> - zależnie od powłoki odporne na benzynę olej i tłuszcze. - odporne na zrywanie i procesy starzenia 	<ul style="list-style-type: none"> - szkło - delikatne elementy drewniane - materiały budowlane - obróbka papieru - maszyny pakujące - przemysł ceramiczny - przemysł tworzyw sztucznych 	<p>Łańcuch bazowy</p> <ul style="list-style-type: none"> - smarowany/na sucho - galwanicznie chromowany na niebiesko (VZ) - niklowany galwanicznie (VN) - stal nierdzewna (SS)

str. 26-31

Łańcuchy o podwójnej podziałce	Wykonanie	Konstrukcja	Zastosowania	Przygotowanie powierzchni
	<ul style="list-style-type: none"> - DIN 8181 - z magazynu - jednorzędowe, wielorzędowe 	<ul style="list-style-type: none"> - rolki wyciskane na zimno - napinany wstępnie min 1/3 gwarantowanej siły zrywającej - podwójna podziałka - taka sama siła zrywająca jak przy łańcuchu o standardowej podziałce 	<ul style="list-style-type: none"> - długie odcinki transportowe - napędy łańcuchowe o wymaganej niskiej masie na m długości 	<ul style="list-style-type: none"> - smarowany/na sucho - galwanicznie chromowany na żółto (SZ) - galwanicznie chromowany na niebiesko (VZ) - niklowany galwanicznie (VN) - niklowany chemicznie (VNc) - stal nierdzewna (SS)

str. 15

Łańcuchy akumulacyjne	Wykonanie	Konstrukcja	Zastosowania	Przygotowanie powierzchni
	<p>Łańcuchy akumulacyjne</p> <ul style="list-style-type: none"> - jednorzędowe, wielorzędowe 	<p>Łańcuchy akumulacyjne</p> <ul style="list-style-type: none"> - rolki wykonane ze stali, poliamidu, antystatyczne 	<p>Transport elementów lub towarów w ciągłym procesie technologicznym.</p> <p>Przykłady</p> <ul style="list-style-type: none"> - maszyny pakujące - systemy transportowe 	<ul style="list-style-type: none"> - smarowany/na sucho - galwanicznie chromowany na żółto (SZ) - galwanicznie chromowany na niebiesko (VZ) - niklowany galwanicznie (VN) - niklowany chemicznie (VNc) - stal nierdzewna (SS)

str. 34

Łańcuchy transferowe	Wykonanie	Konstrukcja	Zastosowania	Przygotowanie powierzchni
	<ul style="list-style-type: none"> - podziałka od 1/2" do 1" - jednorzędowe - poliamidowe bloki transportowe od 34 do 100 mm 	<ul style="list-style-type: none"> - duża żywotność dzięki rolkom i sworzniom wyciskanim na zimno - możliwość przeniesienia dużych obciążeń jako płaski łańcuch transportowy lub płaski pas napędowy zębaty - odporne na ścieranie bloczki poliamidowe - cicha praca dzięki wewnętrznej tłumieniu hałasu - zintegrowane prowadzenie boczne - mała wysokość robocza, możliwa praca w ruchu kroczącym 	<p>Zastosowanie w systemach transportowych do transportu różnorodnych towarów</p> <ul style="list-style-type: none"> - w cegielnach (Np: transport cegieł) - linie produkcyjne urządzeń elektrycznych - transport napojów 	<ul style="list-style-type: none"> - smarowany/na sucho - galwanicznie chromowany na żółto (SZ) - galwanicznie chromowany na niebiesko (VZ) - niklowany galwanicznie (VN) - niklowany chemicznie (VNc) - stal nierdzewna (SS)

str. 35

Technika w skrócie

Przekonajcie się Sami!



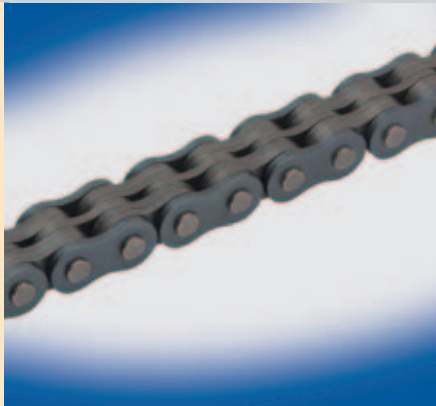

Łańcuchy do pracy po łańcuchach	Wykonanie	Konstrukcja	Zastosowania	Przygotowanie powierzchni
	Z magazynu - podziałka od 3/8" do 1 1/4" - jednorzędowe	- wymiary podstawowe zgodnie z normą DIN - oferowane także z zabierakami	- systemy napędowe, w których koła łańcuchowe są przesunięte względem siebie - systemy transportowe pracujące po łańcuchach	- smarowany/na sucho - galwanicznie chromowany na żółto (SZ) - galwanicznie chromowany na niebiesko (VZ) - niklowany galwanicznie (VN) - niklowany chemicznie (VNC) - stal nierdzewna (SS)
	str. 33			

Łańcuchy z pustymi sworzniami	Wykonanie	Konstrukcja	Zastosowania	Przygotowanie powierzchni
	Z magazynu - jednorzędowe, wielorzędowe	- budowa tak jak w łańcuchach rolkowych z tulejką zamiast sworznia	- do celów transportowych - zastosowanie elementów zabierających w określonych odstępach - mocowanie elementów w tulejkach Przykład - maszyny pakujące	- smarowany/na sucho - galwanicznie chromowany na żółto (SZ) - galwanicznie chromowany na niebiesko (VZ) - niklowany galwanicznie (VN) - niklowany chemicznie (VNC) - stal nierdzewna (SS)
	str. 32			

Łańcuchy Flayera	Wykonanie	Konstrukcja	Zastosowania	Przygotowanie powierzchni
	DIN 8152-3, ISO 4347 DIN 8152-1, ISO 4347 ANSI 29.8 NFE 26107	- bardzo duża siła zrywająca - możliwość przenoszenia dużych sił - małe zużycie	łańcuchy Flayera są łańcuchami do podnoszenia i przenoszenia ciężkich elementów. Przykłady - wózki widłowe - elewatory - technika transportowa	- smarowany / na sucho - zabezpieczony antykorozyjnie
	str. 36-37			

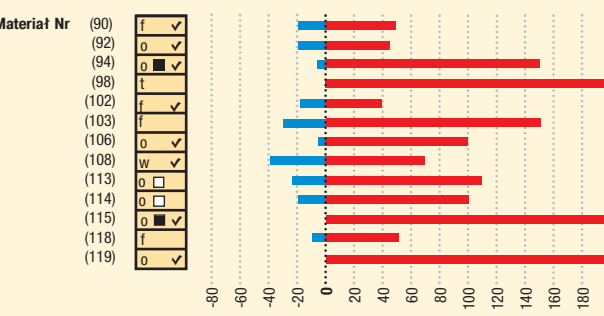
Koła łańcuchowe	Wykonanie	Konstrukcja	Zastosowania	Przygotowanie powierzchni
	Z magazynu - Jednorzędowe, dwurzędowe, trzyczędowe, wielorzędowe - do wszystkich łańcuchów rolkowych i transportowych	- otwór (pasowanie H7) - rowki wg norm DIN 6885 - otwory gwintowane (metryczne) - zęby hartowane indukcyjnie		- na sucho - galwanicznie chromowany na żółto (SZ) - galwanicznie chromowany na niebiesko (VZ) - niklowany galwanicznie (VN) - niklowany chemicznie (VNC) - stal nierdzewna (SS)
	patrz katalog kół łańcuchowych			

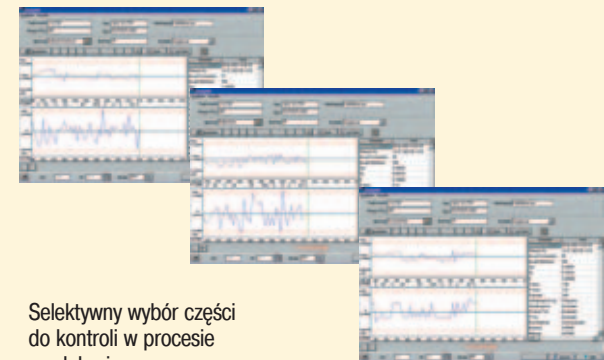
Smarowanie	Statystyczny proces kontrolny SPC	DIN ISO 9001/14001
	 <p>Materiał Nr (90) f ✓ (92) o ✓ (94) t ✓ (98) w ✓ (102) t ✓ (103) f ✓ (106) o ✓ (108) w ✓ (113) t ✓ (114) o ✓ (115) t ✓ (118) o ✓ (119) t ✓</p> <p>f = smar o = olej t = na sucho w = wosk □ = H1 ■ = H2 ✓ = bez silikonu</p> <p>*) max. Temperatura pusзки 50 °C</p>	

Jakość i zertyfikacja	Statystyczny proces kontrolny SPC	DIN ISO 9001/14001
	 <p>Selektywny wybór części do kontroli w procesie produkcyjnym</p>	 

Osprzęt	Przykłady
 A&S smar łańcuchowy-spray  RollRing®  wyciskacz sworzni  napinacz montażowy  napinacze łańcuchowe	

Łańcuchy specjalne	Przykłady
	

Łańcuchy niewymagające konserwacji „Syno/Sovereign“

Łańcuchy do celów napędowych

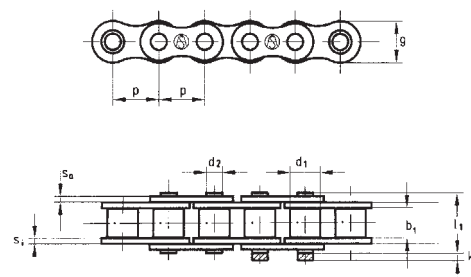

DIN ISO	A&S Nr	Nr zam.	p x b ₁	p [mm]	b ₁ [mm]	d ₁ [mm]	g ₁ [mm]	g ₂ [mm]	s ₁ [mm]	s _a [mm]	d ₂ [mm]	l ₁ [mm]	F _b min [N]	q [kg/m]	Ogniwa łączące						
				Podziałka	min. szerokość wewnętrzna	max. średnica rolki	max. wysokość pływki wewnętrznej	max. Wysokość pływki zewnętrznej	grubość pływki wewnętrznej	grubość pływki zewnętrznej	max. średnica sworznia	max. długość sworznia	siła zrywająca	waga	Nr	4 (B)	7 (A)	26 (E)	30 (C)	58 (S)	59a (L)

Syno

08B-1	1603 SYNO	100 12 24	1/2" x 5/16"	12,70	7,75	8,51	12,1	10,7	1,8	1,5	3,97	16,9	17 500	0,7	•	•	•	•	•	•	•
10B-1	1623 SYNO	100 13 02	5/8" x 3/8"	15,875	9,65	10,16	14,6	12,8	2,0	2,0	4,45	20,4	24 000	1,1	•	•	•	•	•	•	•
12B-1	1642 SYNO	100 13 03	3/4" x 7/16"	19,05	11,68	12,07	16,7	15,3	2,4	2,4	5,08	25,3	30 500	1,5	•	•	•	•	•	•	•
16B-1	1666 SYNO	100 13 07	1" x 0,67"	25,40	17,02	15,88	20,2	18,7	3,7	3,0	7,00	35,0	65 000	1,8	•	•	•	•	•	•	•

08A-1	40 SYNO	100 13 08	1/2" x 5/16"	12,70	7,85	7,95	12,1	10,7	1,8	1,5	3,97	16,9	17 500	0,7	•	•	•	•	•	•	•
10A-1	50 SYNO	100 13 09	5/8" x 3/8"	15,875	9,40	10,16	14,6	12,8	2,0	2,0	4,45	20,4	27 800	1,1	•	•	•	•	•	•	•
12A-1	60 SYNO	100 13 10	3/4" x 1/2"	19,05	12,57	11,91	16,7	15,3	2,4	2,4	5,08	25,3	36 000	1,5	•	•	•	•	•	•	•
16A-1	80 SYNO	100 13 11	1" x 0,67"	25,40	15,75	15,88	20,2	18,7	3,7	3,0	7,0	35,0	65 000	1,8	•	•	•	•	•	•	•

DIN ISO	A&S Nr	Nr zam.	p x b ₁	p [mm]	b ₁ [mm]	d ₁ [mm]	g ₁ [mm]	g ₂ [mm]	s ₁ [mm]	s _a [mm]	d ₂ [mm]	l ₁ [mm]	F _b min [N]	q [kg/m]	Ogniwa łączące						
				Podziałka	min. szerokość wewnętrzna	max. średnica rolki	max. wysokość pływki wewnętrznej	max. Wysokość pływki zewnętrznej	grubość pływki wewnętrznej	grubość pływki zewnętrznej	max. średnica sworznia	max. długość sworznia	siła zrywająca	waga	Nr	4 (B)	7 (A)	26 (E)	30 (C)	58 (S)	59a (L)

Sovereign

08B-1	1603 SOVEREIGN	100 12 83	1/2" x 5/16"	12,70	7,75	8,51	11,1	10,5	1,5	1,5	4,45	17,0	19 000	0,7	•	•	•	•	•	•	•
10B-1	1623 SOVEREIGN	100 12 84	5/8" x 3/8"	15,875	9,65	10,16	14,6	12,8	1,5	1,5	5,08	18,8	24 000	1,0	•	•	•	•	•	•	•
12B-1	1642 SOVEREIGN	100 12 85	3/4" x 7/16"	19,05	11,68	12,07	16,0	14,8	1,8	1,8	5,72	21,9	30 500	1,3	•	•	•	•	•	•	•
16B-1	1666 SOVEREIGN	100 14 52	1" x 0,67"	25,40	17,02	15,88	20,6	20,6	4,1	3,1	8,27	34,85	67 000	2,7	•	•	•	•	•	•	•

Odpowiednie mocowania i zabieraki znajdują się na str. 16-23!

Łańcuchy ze stali nierdzewnej "Coris"

Łańcuchy do celów napędowych

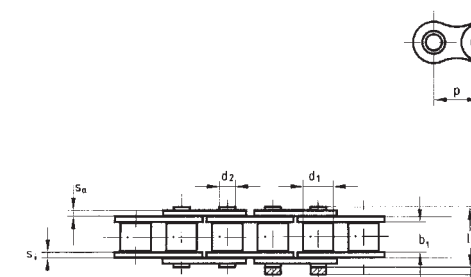
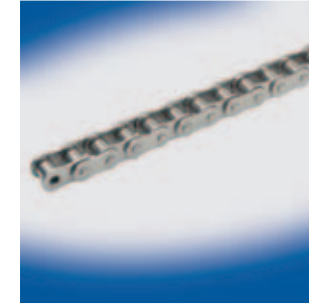

DIN ISO	A&S Nr	Nr zam.	p x b ₁	p [mm]	b ₁ [mm]	d ₁ [mm]	g [mm]	s ₁ [mm]	s _a [mm]	d ₂ [mm]	l ₁ [mm]	k [mm]	e [mm]	F _b min [N]	q [kg/m]	Ogniwa łączące						
				Podziałka	min. szerokość wewnętrzna	max. średnica rolki	max. wysokość pływki wewnętrznej	grubość pływki wewnętrznej	grubość pływki zewnętrznej	max. średnica sworznia	max. długość sworznia	max. długość spinki	odległość osi	siła zrywająca	waga	Nr	4 (B)	7 (A)	26 (E)	30 (C)	58 (S)	59a (L)

Łańcuchy jednorzędowe

04	1161SS	100 08 93		6,00	2,80	4,00	5,00	0,57	0,57	1,85	7,40	2,90		2 000	0,12	•	•	•	•	•	•
05B-1	1181SS	100 05 46		8,00	3,00	5,00	7,10	0,73	0,73	2,31	8,60	3,10		2 950	0,18	•	•	•	•	•	•
06B-1	2191SS	100 13 35*	3/8" x 7/32"	9,525	5,72	6,35	8,20	1,21	1,00	3,28	13,50	3,30		6 850	0,41	•	•	•	•	•	•
081	1001SS	100 09 43	1/2" x 1/8"	12,70	3,30	7,75	9,90	1,00	1,00	3,66	10,20	1,50		7 000	0,28	•	•	•	•	•	•
08B-1	1603SS	100 12 46	1/2" x 5/16"	12,70	7,75	8,51	11,80	1,50	1,50	4,45	17,00	3,90		12 000	0,70	•	•	•	•	•	•
10B-1	1623SS	100 12 47	5/8" x 3/8"	15,875	9,65	10,16	14,70	1,50	1,50	5,08	19,60	4,10		14 700	0,95	•	•	•	•	•	•
12B-1	1642SS	100 12 48	3/4" x 7/16"	19,05	11,68	12,07	16,10	1,76	1,76	5,72	22,70	4,60		18 640	1,25	•	•	•	•	•	•
16B-1	1666SS	100 12 62	1" x 0,67"	25,40	17,02	15,88	21,00	3,70	3,00	8,28	36,10	5,40		43 160	2,70	•	•	•	•	•	•

08A-1	40SS	100 13 36	1/2" x 5/16"	12,70	7,85	7,95	12,00	1,50	1,50	3,96	17,80	3,90		10 690	0,60	•	•	•	•	•	•
10A-1	50SS	100 13 34	5/8" x 3/8"	15,875	9,40	10,16	15,00	2,00	2,00	5,08	21,80	4,10		16 810	1,00	•	•	•	•	•	•
12A-1	60SS	100 13 37	3/4" x 1/2"	19,05	12,57	11,91	18,00	2,40	2,40	5,94	26,90	4,60		24 030	1,50	•	•	•	•	•	•
16A-1	80SS	100 13 42	1" x 0,67"	25,40	15,75	15,88	24,10	3,00	3,00	7,92	33,50	5,40		51 000	2,6	•	•	•	•	•	•

DIN ISO	A&S Nr	Nr zam.	p x b ₁	p [mm]	b ₁ [mm]	d ₁ [mm]	g [mm]	s ₁ [mm]	s _a [mm]	d ₂ [mm]	l ₂ [mm]	k [mm]	e [mm]	F _b min [N]	q [kg/m]	Ogniwa łączące						
				Podziałka	min. szerokość wewnętrzna	max. średnica rolki	max. wysokość pływki wewnętrznej	grubość pływki wewnętrznej	grubość pływki zewnętrznej	max. średnica sworznia	max. długość sworznia	max. długość spinki	odległość osi	siła zrywająca	waga	Nr	4 (B)	7 (A)	26 (E)	30 (C)	58 (S)	59a (L)

Łańcuchy dwurzędowe

05B-2	1181-2SS	100 09 45		8,00	3,00	5,00	7,10	0,73	0,73	2,31	14,30	3,10	5,64	6 800	0,36	•	•	•	•	•	•
06B-2	2192-2SS	100 12 88*	3/8" x 7/32"	9,525	5,72	6,35	8,20	1,25	1,00	3,28	23,80	3,30	10,24	11 900	0,78	•	•	•	•	•	•
08B-2	1603-2SS	100 12 78	1/2" x 5/16"	12,70	7,75	8,51	11,80	1,50	1,50	4,45	31,00	3,90	13,92	23 430	1,35	•	•	•	•	•	•
10B-2	1623-2SS	100 12 96	5/8" x 3/8"	15,875	9,65	10,16	14,70	1,50	1,50	5,08	36,20	4,10	16,59	29 430	1,85	•	•	•	•	•	•
12B-2	1642-2SS	100 12 97	3/4" x 7/16"	19,05	11,68	12,07	16,10	1,76	1,76	5,72	42,20	4,60	19,46	37 280	2,50	•	•	•	•	•	•
16B-2	1666-2SS	100 12 98	1" x 0,67"	25,40	17,02	15,88	21,00	4,00	3,00	8,28	68,00	5,40	31,88	68 000	5,40	•	•	•	•	•	•

* tylko z prostymi ogniwami Odpowiednie mocowania i zabieraki znajdują się na str. 16-23!

Łańcuchy rolkowe wg norm zakładowych

Łańcuchy do celów napędowych

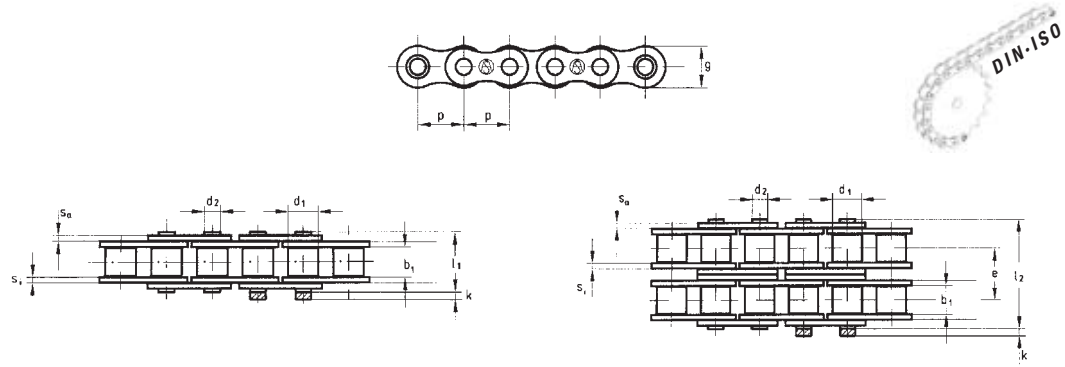
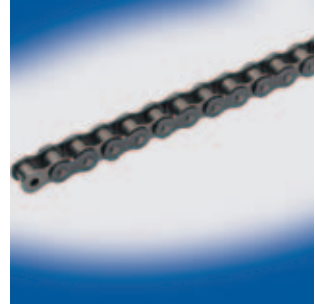

DIN	A&S	Nr zam.	p x b ₁	p	b ₁	d ₁	g	s ₁	s _a	d ₂	l ₁	k	e	F _b min	q	Nr	4	7	26	30	58	59a
ISO				[mm]	[mm]	[mm]	[mm]	[mm]	[mm]	[mm]	[mm]	[mm]	[mm]	[N]	[kg/m]	DIN	(B)	(A)	(E)	(C)	(S)	(L)
Łańcuchy rolkowe																						
1141-B	100 00 01*			4,00	2,70	2,50	4,10	0,57	0,57	1,65	6,70	1,20		1 800	0,07							
1191	100 00 09	3/8" x 1/8"		9,525	3,20	6,00	8,70	0,90	0,90	2,80	8,80	1,50		6 500	0,23							
1591	100 00 11**	3/8" x 5/32"		9,525	3,94	6,35	8,20	1,25	1,00	3,28	10,90	1,50		9 100	0,34							
1003	100 00 25	1/2" x 3/16"		12,70	4,88	7,75	9,90	1,00	1,00	3,66	10,70	1,50		8 200	0,32							
1351	100 05 20	1/2" x 1/8"		12,70	3,30	7,75	9,60	1,10	0,95	4,09	9,80	1,50		9 100	0,30							
1352	100 05 22	1/2" x 3/16"		12,70	4,88	7,75	9,60	1,10	0,95	4,09	11,40	1,50		9 100	0,35							
1202	100 00 22	1/2" x 3/16"		12,70	4,88	7,75	10,70	1,50	1,50	3,97	13,80	2,60		15 000	0,47							
1203	100 00 23	1/2" x 1/4"		12,70	6,40	7,75	10,70	1,50	1,50	3,97	15,30	2,60		15 000	0,51							
1602	100 00 28	1/2" x 1/4"		12,70	6,40	8,51	11,80	1,50	1,50	4,45	15,10	3,90		18 200	0,56							
1603-S	100 00 34	1/2" x 5/16"		12,70	7,75	8,51	12,10	1,80	1,80	4,45	17,70	3,90		23 000	0,77							
1622	100 00 38	5/8" x 1/4"		15,875	6,48	10,16	14,60	1,50	1,50	5,08	15,60	4,10		24 000	0,76							
1642-T	100 00 59	3/4" x 7/16"		19,05	11,68	12,07	16,70	2,40	2,40	6,10	25,00	4,60		43 000	1,56							
1644	100 00 62	3/4" x 1 7/32"		19,05	13,50	12,07	16,70	2,90	2,90	5,72	28,50	4,60		34 000	1,76							
1262-S	100 01 98	1" x 1/2"		25,40	12,70	14,00	23,20	3,50	3,00	7,50	29,80	5,00		75 000	2,20							
1263	100 00 65	1" x 1/2"		25,40	12,70	12,70	20,20	3,00	2,40	7,00	27,80	5,00		47 000	1,56							
1665	100 00 66	1" x 1/2"		25,40	12,70	15,88	20,20	3,70	3,00	8,28	30,80	5,40		65 000	2,20							
1666-S	100 02 25	1" x 0,67"		25,40	17,02	15,88	20,20	4,00	3,00	8,28	35,00	5,40		75 000	2,70							
1812	100 00 73	30 x 0,67"		30,00	17,02	15,88	22,20	3,70	3,00	8,28	35,00	5,40		65 000	2,54							
1665-2	100 02 50	1" x 1/2"		25,40	12,70	15,88	20,20	3,70	3,00	8,28	58,30	5,40	27,70	124 000	4,44							

* Łańcuchy tulejkowe ** z prostymi ogniwami



Łańcuchy o podwójnej podziałce

Łańcuchy do celów napędowych

DIN 8181, BS 4687 ISO 1275

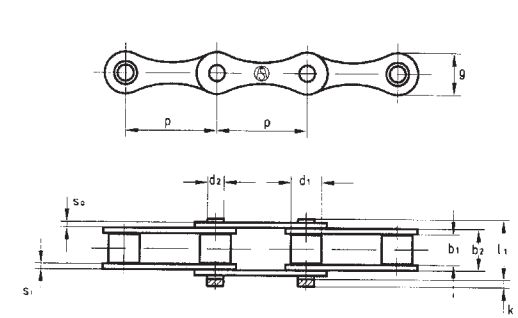

DIN	A&S	Nr zam.	p x b ₁	p	b ₁	d ₁	g	s ₁	s _a	d ₂	l ₁	k	e	F _b min	q	Nr	4	7	26	30	58	59a
ISO				[mm]	[mm]	[mm]	[mm]	[mm]	[mm]	[mm]	[mm]	[mm]	[mm]	[N]	[kg/m]	DIN	(B)	(A)	(E)	(C)	(S)	(L)
Typ-B																						
208 B	1603-L	100 00 37	1" x 5/16"	25,40	7,75	8,51	11,80	1,50	1,50	4,45	17,00	3,90		18 200	0,44							
208 B	1603-LGF*	100 04 37	1" x 5/16"	25,40	7,75	8,51	11,80	1,50	1,50	4,45	17,00	3,90		18 200	0,45							
210 B	1623-L	100 00 47	1 1/4" x 3/8"	31,75	9,65	10,16	14,70	1,50	1,50	5,08	19,60	4,10		22 700	0,56							
210 B	1623-LGF*	100 02 42	1 1/4" x 3/8"	31,75	9,65	10,16	14,70	1,50	1,50	5,08	19,60	4,10		22 700	0,73							
212 B	1642-L	100 00 58	1 1/2" x 7/16"	38,10	11,68	12,07	16,10	1,76	1,76	5,72	22,70	4,60		29 500	0,73							
212 B	1642-LGF*	100 01 49	1 1/2" x 7/16"	38,10	11,68	12,07	16,10	1,76	1,76	5,72	22,70	4,60		29 500	0,76							
216 B	1666-L	100 00 71	2" x 0,67"	50,80	17,02	15,88	21,00	3,70	3,00	8,28	36,10	5,40		60 000	1,71							
216 B	1666-LGF*	100 02 37	2" x 0,67"	50,80	17,02	15,88	21,00	3,70	3,00	8,28	36,10	5,40		60 000	1,98							
220 B	1682-L	100 00 78	2 1/2" x 3/4"	63,50	19,56	19,05	22,80	4,40	4,00	10,19	43,20	6,10		95 000	2,00							
220 B	1682-LGF*	100 02 58	2 1/2" x 3/4"	63,50	19,56	19,05	26,40	4,40	4,10	10,19	43,20	6,10		95 000	2,40							
224 B	1702-L	100 00 82	3" x 1"	76,20	25,40	25,40	33,40	5,40	5,00	14,63	53,40	6,60		160 000	4,93							
Typ-A																						
208 A	2040	100 00 93	1" x 5/16"	25,40	7,85	7,95	12,00	1,50	1,50	3,96	17,80	3,90		14 100	0,40							
208 A	C 2040*	100 03 98	1" x 5/16"	25,40	7,85	7,95	12,00	1,50	1,50	3,96	17,80	3,90		16 900	0,50							
210 A	2050	100 00 99	1 1/4" x 3/8"	31,75	9,40	10,16	15,00	2,00	2,00	5,08	21,80	4,10		27 800	0,69							
210 A	C 2050*	100 03 99	1 1/4" x 3/8"	31,75	9,40	10,16	15,00	2,00	2,00	5,08	21,80	4,10		27 800	0,84							
212 A	2060	100 01 07	1 1/2" x 1/2"	38,10	12,57	11,91	18,00	2,40	2,40	5,94	26,90	4,60		38 000	1,02							
212 A	C 2060*	100 03 04	1 1/2" x 1/2"	38,10	12,57	11,91	18,00	3,17	3,17	5,94	28,60	4,60		38 000	1,44							
216 A	2080	100 02 84	2" x 5/8"	50,80	15,75	15,88	24,10	3,00	3,00	7,92	33,50	5,40		56 700	1,76							
216 A	C 2080*	100 09 56	2" x 5/8"	50,80	15,75	15,88	24,10	4,00	4,00	7,92	35,80	5,40		65 000	2,42							

* z prostymi ogniwami

Łańcuchy rolkowe z zabierakami typu M1

Łańcuchy do celów transportowych

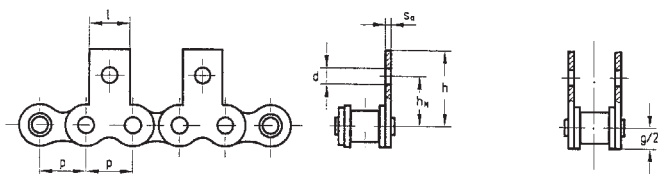
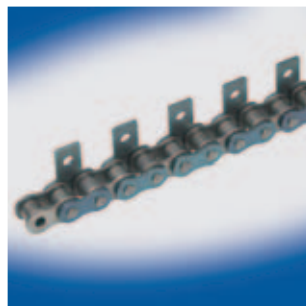

prętka wewnętrzna

prętka zewnętrzna

DIN ISO	l [mm]	h [mm]	h _M [mm]	d [mm]	s _i [mm]	s _a [mm]	g/2 [mm]	
---------	--------	--------	---------------------	--------	---------------------	---------------------	----------	--

Standard

04	110 10 58	110 10 59	5,80	10,00	6,80	2,30	0,57	0,57	2,50	WN*
05 B	110 03 97	110 07 09	7,80	11,90	8,60	2,30	0,73	0,73	3,40	WN
06 B	110 02 48	110 02 44	8,00	14,50	10,10	3,30	1,25	1,00	4,00	WN
08 B	111 37 63	111 37 64	11,00	20,80	13,00	4,30	1,50	1,50	5,80	DIN
08 B	110 05 09	110 05 05	11,00	20,80	13,70	4,30	1,50	1,50	5,80	WN
10 B	110 07 51	110 07 47	14,00	24,90	16,50	5,30	1,50	1,50	7,30	DIN
12 B	111 37 87	111 37 88	18,00	28,20	21,00	6,60	1,76	1,76	8,10	DIN
12 B	110 09 64	110 09 60	18,00	28,20	18,50	6,40	1,76	1,76	8,10	WN
16 B	111 37 31	111 37 32	24,00	39,70	23,00	6,60	3,70	3,00	10,30	DIN
16 B	110 15 67	110 15 63	24,00	40,00	27,40	8,40	3,70	3,00	10,00	WN
20 B	111 37 99	111 38 00	30,00	47,50	30,50	8,40	4,40	3,50	12,50	DIN
20 B	110 17 85	110 17 81	30,00	47,50	33,00	10,40	4,40	4,10	12,50	WN
24 B	110 18 95	110 18 91	36,00	61,50	42,70	10,50	5,40	5,00	16,70	WN



08 A	110 67 96	110 22 86	9,50	17,50	12,70	3,30	1,50	1,50	5,50	DIN
10 A	110 34 19	110 34 67	12,70	24,60	15,90	5,30	2,00	2,00	7,20	DIN
12 A	110 76 37	110 76 42	15,90	26,00	18,30	5,30	2,40	2,40	8,60	DIN
16 A	111 37 25	111 30 95	24,00	39,70	24,60	6,60	3,00	3,00	10,30	DIN

Norma zakładowa

1351	110 92 14	110 92 15	9,50	18,90	13,40	3,30	1,00	1,00	4,80	WN
1352	110 92 14	110 92 15	9,50	18,90	13,40	3,30	1,00	1,00	4,80	WN
1202	110 03 18	110 03 34	11,50	17,70	11,60	4,30	1,50	1,50	5,30	WN
1203	110 03 18	110 03 34	11,50	17,70	11,60	4,30	1,50	1,50	5,30	WN
1622	110 07 51	110 07 47	14,00	24,90	16,50	5,30	1,50	1,50	7,30	WN

Łańcuchy o podwójnej podziałce

208 B	110 43 29	110 43 23	23,80	20,90	13,70	4,30	1,50	1,50	5,80	WN
210 B	110 43 73	110 43 69	25,40	24,90	16,50	5,30	1,50	1,50	7,30	WN
212 B	110 12 36	110 12 32	20,00	28,30	18,50	6,40	1,76	1,76	8,00	WN
216 B	110 16 50	110 16 46	40,00	40,00	27,40	8,40	3,70	3,00	10,30	WN
220 B	111 19 91	111 19 92	40,00	48,70	33,00	10,50	4,40	4,10	11,30	WN
224 B	110 68 81	110 68 77	70,00	61,50	42,70	10,50	5,40	5,00	16,70	WN

208 A	110 06 47	110 07 71	23,80	20,90	11,10	3,30	1,50	1,50	5,70	WN
210 A	110 76 07	110 76 12	25,40	24,90	14,30	5,30	2,00	2,00	7,40	WN
212 A	110 76 62	110 76 67	28,60	30,20	19,00	5,30	2,40	2,40	8,80	WN

Wymiary łańcucha bazowego patrz str. 8

* WN = norma zakładowa, uwzględnić różnice wymiarowe

prętka wewnętrzna

prętka zewnętrzna

DIN ISO	l [mm]	h [mm]	h _M [mm]	d [mm]	s _i [mm]	s _a [mm]	g/2 [mm]	
---------	--------	--------	---------------------	--------	---------------------	---------------------	----------	--

Łańcuchy ze stali nierdzewnej „Coris“

06 B	111 68 58	111 62 38	8,00	14,50	10,10	3,30	1,21	1,00	4,10	WN*
08 B	111 54 35	111 54 36	11,00	20,80	13,00	4,50	1,50	1,50	5,90	WN
10 B	111 54 48	111 54 49	14,00	24,90	16,50	5,50	1,50	1,50	7,30	WN
12 B	-	111 60 84	18,00	28,20	21,00	6,60	1,76	1,76	8,10	WN
16 B	-	111 58 18	24,00	39,70	23,00	6,60	3,76	3,00	10,40	WN

08 A	111 60 92	111 55 58	9,50	17,50	12,70	4,50	1,50	1,50	5,60	WN
10 A	-	111 54 83	14,00	24,90	15,90	5,50	2,00	2,00	7,30	WN
12 A	-	111 56 32	15,90	26,00	18,30	5,50	2,40	2,40	8,80	WN
16 A	-	111 57 89	24,00	39,70	24,60	6,60	3,00	3,00	11,50	WN

Łańcuchy niewymagające konserwacji „Syno“

08 B	111 67 72	111 67 26	11,00	20,80	13,00	4,50	1,50	1,50	5,90	WN
10 B	-	111 66 47	12,70	24,60	16,50	5,50	2,00	2,00	7,30	WN
12 B	111 68 96	111 67 17	18,00	28,20	21,00	6,60	2,40	2,40	8,40	WN
16 B	111 72 45	111 72 46	24,00	39,70	23,00	6,60	3,70	3,00	10,40	WN

08 A	-	111 66 56	9,50	17,50	12,70	4,50	1,50	1,50	5,90	WN
10 A	-	111 66 47	12,70	24,60	16,50	5,50	2,00	2,00	7,30	WN
12 A	111 69 23	111 69 24	15,90	26,00	18,30	6,60	2,40	2,40	8,40	WN
16 A	-	111 72 46	24,00	39,70	23,00	6,60	3,70	3,00	10,40	WN

* WN = norma zakładowa, uwzględnić różnice wymiarowe

Łańcuchy rolkowe z zabierakami typu M2

Łańcuchy do celów transportowych

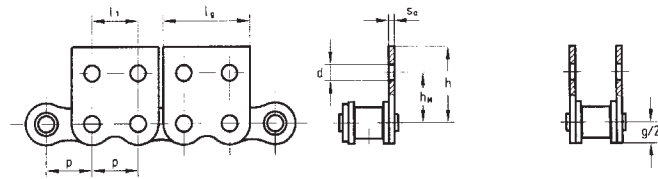
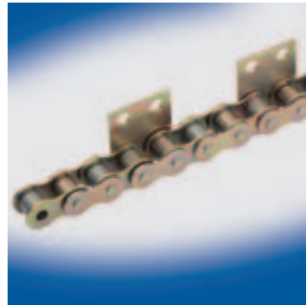

Płytki wewnętrzne

Płytki zewnętrzne

DIN ISO	h [mm]	h _M [mm]	d [mm]	s ₁ [mm]	s _a [mm]	g/2 [mm]	l _g [mm]	l ₁ [mm]			
Standard											
04	110 11 22	110 11 25	10,00	6,80	2,30	0,57	0,57	2,50	11,10	6,00	WN*
05 B	110 05 99	110 01 26	11,90	8,60	2,30	0,73	0,73	3,40	14,80	8,00	WN
06 B	110 02 50	110 02 46	14,50	10,10	3,30	1,25	1,00	4,00	17,60	9,50	WN
08 B	111 37 66	111 37 67	20,80	13,00	4,30	1,50	1,50	5,80	24,40	12,70	DIN
08 B	110 05 11	110 05 07	20,80	13,70	4,30	1,50	1,50	5,80	24,40	12,70	WN
10 B	110 07 53	110 07 49	24,90	16,50	5,30	1,50	1,50	7,30	29,90	15,90	DIN
12 B	111 37 90	111 37 91	28,20	21,00	6,60	1,76	1,76	8,10	35,40	19,00	DIN
12 B	110 09 66	110 09 62	28,20	18,50	6,40	1,76	1,76	8,10	35,40	19,00	WN
16 B	111 37 34	111 37 35	39,70	23,00	6,60	3,70	3,00	10,30	46,20	25,40	DIN
16 B	110 15 69	110 15 65	40,00	27,40	8,40	3,70	3,00	10,00	45,40	25,40	WN
20 B	111 38 02	111 38 03	47,50	30,50	8,40	4,40	3,50	12,50	57,00	31,70	DIN
20 B	110 17 87	110 17 83	47,50	33,00	10,40	4,40	4,10	12,50	57,00	31,70	WN
24 B	110 18 97	110 18 93	61,50	42,70	10,50	5,40	5,00	16,70	71,50	38,10	WN



08 A	110 67 98	110 68 01	17,50	12,70	3,30	1,50	1,50	5,50	24,00	12,70	DIN
10 A	110 54 20	110 56 27	24,60	15,90	5,30	2,00	2,00	7,20	29,90	15,80	DIN
12 A	110 76 39	110 26 31	27,70	18,30	5,30	2,40	2,40	8,60	35,60	19,00	DIN
16 A	111 30 99	111 37 27	39,70	24,60	6,60	3,00	3,00	10,30	46,20	25,40	DIN

Norma zakładowa

1351	110 92 20	110 92 21	18,90	13,40	3,30	1,00	1,00	4,80	22,50	12,70	WN
1352	110 92 20	110 92 21	18,90	13,40	3,30	1,00	1,00	4,80	22,50	12,70	WN
1202	110 62 93	110 13 92	17,70	11,60	4,30	1,50	1,50	5,30	23,40	12,70	WN
1203	110 62 93	110 13 92	17,70	11,60	4,30	1,50	1,50	5,30	23,40	12,70	WN
1622	110 07 53	110 07 49	24,90	16,50	5,30	1,50	1,50	7,30	29,90	15,90	WN

Łańcuchy o podwójnej podziałce

208 B	110 43 31	110 43 25	20,80	13,70	4,30	1,50	1,50	5,80	37,10	12,70	WN
210 B	110 43 75	110 43 71	24,90	16,50	5,30	1,50	1,50	7,30	46,70	15,80	WN
212 B	110 12 38	110 12 34	28,30	18,50	6,40	1,76	1,76	8,00	54,40	19,00	WN
216 B	110 16 52	110 16 48	40,00	27,40	8,40	3,70	3,00	10,30	71,30	25,40	WN
220 B	111 19 97	111 19 98	48,70	33,00	10,50	4,40	4,10	11,30	86,50	31,70	WN

208 A	110 06 76	110 07 91	20,90	11,10	3,30	1,50	1,50	5,70	23,80	9,50	WN
210 A	110 76 09	110 76 14	24,90	14,30	5,30	2,00	2,00	7,40	25,40	11,90	WN
212 A	110 76 64	110 76 69	30,20	19,00	5,30	2,40	2,40	8,80	28,60	14,30	WN

Wymiary łańcucha bazowego patrz str. 8

* WN = norma zakładowa, uwzględnić różnice wymiarowe

Płytki wewnętrzne

Płytki zewnętrzne

DIN ISO	h [mm]	h _M [mm]	d [mm]	s ₁ [mm]	s _a [mm]	g/2 [mm]	l _g [mm]	l ₁ [mm]			
Łańcuchy ze stali nierdzewnej „Coris“											
06 B	111 68 59	111 62 40	14,50	10,10	3,30	1,21	1,00	4,10	17,60	9,50	WN*
08 B	111 54 38	111 54 39	20,80	13,00	4,50	1,50	1,50	5,90	24,40	12,70	WN
10 B	111 54 51	111 54 52	24,90	16,50	5,50	1,50	1,50	7,30	29,90	15,80	WN
12 B	111 78 10	111 60 00	28,20	21,00	6,60	1,76	1,76	8,10	35,40	19,00	WN
16 B	-	111 58 20	39,70	23,00	6,60	3,76	3,00	10,40	46,20	25,40	WN

08 A	111 60 93	111 55 60	17,50	12,70	4,50	1,50	1,50	5,60	24,00	12,70	WN
10 A	-	111 54 85	24,90	15,90	5,50	2,00	2,00	7,30	29,90	15,80	WN
12 A	-	111 56 34	26,00	18,30	5,50	2,40	2,40	8,80	35,60	19,00	WN
16 A	-	111 57 91	39,70	24,60	6,60	3,00	3,00	11,50	46,20	25,40	WN

Łańcuchy niewymagające konserwacji „Syno“

08 B	111 67 74	111 67 27	20,80	13,00	4,50	1,50	1,50	5,90	24,40	12,70	WN
10 B	-	111 66 48	24,60	16,50	5,50	2,00	2,00	7,30	29,90	15,80	WN
12 B	111 68 98	111 67 18	28,20	21,00	6,60	2,40	2,40	8,40	35,60	19,00	WN
16 B	111 72 48	111 72 49	39,70	23,00	6,60	3,70	3,00	10,40	46,20	25,40	WN

08 A	-	111 66 57	17,50	12,70	4,50	1,50	1,50	5,90	24,00	12,70	WN
10 A	-	111 66 48	24,60	16,50	5,50	2,00	2,00	7,30	29,90	15,80	WN
12 A	111 69 26	111 69 27	26,00	18,30	6,60	2,40	2,40	8,40	35,60	19,00	WN
16 A	-	111 72 49	39,70	23,00	6,60	3,70	3,00	10,40	46,20	25,40	WN

* WN = norma zakładowa, uwzględnić różnice wymiarowe

Łańcuchy rolkowe z zabierakami typu K1

Łańcuchy do celów transportowych

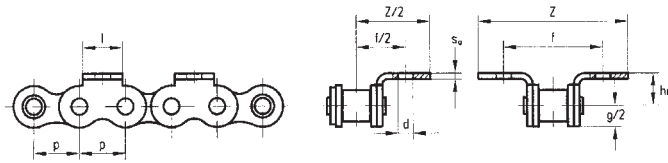
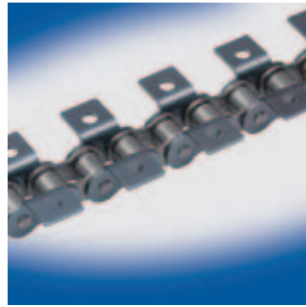

Prętka wewnętrzna

Prętka zewnętrzna

Wymiar orientacyjny

DIN ISO	l [mm]	h _K [mm]	d [mm]	s _i [mm]	s _a [mm]	g/2 [mm]	f [mm]	Z [mm]	
---------	--------	---------------------	--------	---------------------	---------------------	----------	--------	--------	--

Standard

04	110 11 05	110 11 06	5,80	4,50	2,30	0,57	0,57	2,50	11,20	17,60	WN*
05 B	110 01 18	110 01 19	7,80	5,30	2,30	0,73	0,73	3,40	13,50	21,50	WN
06 B	110 02 60	110 02 56	8,00	6,70	3,30	1,25	1,00	4,00	19,60	28,50	WN
08 B	111 37 69	111 37 70	11,00	8,90	4,30	1,50	1,50	5,80	25,40	41,70	DIN
08 B	110 05 21	110 05 17	11,00	8,50	4,30	1,50	1,50	5,80	27,60	41,90	WN
10 B	111 07 63	110 07 59	14,00	10,30	5,30	1,50	1,50	7,30	31,80	49,60	DIN
12 B	111 37 93	111 37 94	18,00	13,50	6,60	1,76	1,76	8,10	38,10	52,70	DIN
12 B	110 09 76	110 09 72	18,00	12,20	6,40	1,76	1,76	8,10	35,20	54,60	WN
16 B	111 37 37	111 37 38	24,00	15,90	6,60	3,70	3,00	10,30	50,80	85,60	DIN
16 B	110 15 79	110 15 75	24,00	17,00	8,40	3,70	3,00	10,00	58,00	83,80	WN
20 B	111 38 05	111 38 06	30,00	19,90	8,40	4,40	3,50	12,50	63,50	100,00	DIN
20 B	110 17 97	110 17 93	30,00	21,00	10,40	4,40	4,10	12,50	69,00	98,70	WN
24 B	110 19 07	110 19 03	36,00	28,00	10,50	5,40	5,00	16,70	88,00	124,70	WN



08 A	110 22 82	110 22 74	9,50	7,90	3,30	1,50	1,50	5,50	25,40	35,80	DIN
10 A	110 59 99	110 61 97	12,70	10,30	5,30	2,00	2,00	7,20	31,80	49,80	DIN
12 A	110 76 51	110 26 95	15,90	11,90	5,30	2,40	2,40	8,60	38,10	58,00	DIN
16 A	111 31 06	111 31 07	24,00	15,90	6,60	3,00	3,00	10,30	50,80	82,60	DIN

Norma zakładowa

1351	110 92 29	110 92 09	9,50	8,00	3,30	1,00	1,00	4,80	20,60	31,60	WN
1352	110 92 29	110 92 09	9,50	8,00	3,30	1,00	1,00	4,80	22,20	33,20	WN
1202	110 62 99	110 03 27	11,50	8,00	4,30	1,50	1,50	5,30	21,40	33,60	WN
1203	110 62 99	110 03 27	11,50	8,00	4,30	1,50	1,50	5,30	23,00	35,20	WN
1622	110 07 63	110 07 59	14,00	10,30	5,30	1,50	1,50	7,30	28,40	45,30	WN

Łańcuchy o podwójnej podziałce

208 B	110 43 41	110 43 37	23,80	8,50	4,30	1,50	1,50	5,80	27,60	42,50	WN
210 B	110 43 87	110 43 83	25,40	10,50	5,30	1,50	1,50	7,30	31,60	48,50	WN
212 B	110 12 48	110 12 44	20,00	12,20	6,40	1,76	1,76	8,00	35,20	54,80	WN
216 B	110 16 62	110 16 58	40,00	17,00	8,40	3,70	3,00	10,30	58,00	83,80	WN
220 B	111 20 06	111 20 07	40,00	21,00	10,50	4,40	4,10	11,30	69,00	98,70	WN
224 B	110 68 93	111 68 89	70,00	28,00	10,50	5,40	5,00	16,70	88,00	124,70	WN

208 A	110 08 37	110 23 52	23,80	9,10	3,30	1,50	1,50	5,70	25,40	40,60	WN
210 A	110 76 22	110 76 27	25,40	11,10	5,30	2,00	2,00	7,40	31,80	48,90	WN
212 A	110 76 77	110 27 92	28,60	14,70	5,30	2,40	2,40	8,80	42,80	58,00	WN

Wymiary łańcucha bazowego patrz str. 8

* WN = norma zakładowa, uwzględnić różnice wymiarowe

Prętka wewnętrzna

Prętka zewnętrzna

Wymiar orientacyjny

DIN ISO	l [mm]	h _K [mm]	d [mm]	s _i [mm]	s _a [mm]	g/2 [mm]	f [mm]	Z [mm]	
---------	--------	---------------------	--------	---------------------	---------------------	----------	--------	--------	--

Łańcuchy ze stali nierdzewnej „Coris“

06 B	111 68 60	111 62 42	8,00	6,70	3,30	1,21	1,00	4,10	19,60	28,50	WN*
08 B	111 54 41	111 54 42	11,00	8,90	4,50	1,50	1,50	5,90	25,40	41,50	WN
10 B	111 54 54	111 54 55	14,00	10,30	5,50	1,50	1,50	7,30	31,80	49,60	WN
12 B	111 67 23	111 57 53	18,00	13,50	6,60	1,76	1,76	8,10	38,10	52,70	WN
16 B	111 57 63	111 58 22	24,00	15,90	6,60	3,76	3,00	10,40	50,80	85,60	WN

08 A	111 60 94	111 55 62	9,50	7,90	4,50	1,50	1,50	5,60	25,40	35,80	WN
10 A	-	111 54 87	14,00	10,30	5,50	2,00	2,00	7,30	31,80	51,40	WN
12 A	111 63 77	111 56 36	15,90	11,90	5,50	2,40	2,40	8,80	38,10	54,70	WN
16 A	-	111 57 93	24,00	15,90	6,60	3,00	3,00	11,50	50,80	82,00	WN

Łańcuchy niewymagające konserwacji „Syno“

08 B	111 67 76	111 67 28	11,00	8,90	4,50	1,50	1,50	5,90	25,40	41,80	WN
10 B	-	111 66 49	12,70	10,30	5,50	2,00	2,00	7,30	31,80	49,80	WN
12 B	111 68 94	111 67 19	18,00	13,50	6,60	2,40	2,40	8,40	38,10	56,20	WN
16 B	111 72 51	111 72 52	24,00	15,90	6,60	3,70	3,00	10,40	50,80	85,60	WN

08 A	-	111 66 58	9,50	7,90	4,50	1,50	1,50	5,90	25,60	36,00	WN
10 A	-	111 66 49	12,70	10,30	5,50	2,00	2,00	7,30	31,80	49,80	WN
12 A	111 69 29	111 69 30	15,90	11,90	6,60	2,40	2,40	8,40	38,10	54,60	WN
16 A	-	111 72 52	24,00	15,90	6,60	3,70	3,00	10,40	50,80	85,60	WN

* WN = norma zakładowa, uwzględnić różnice wymiarowe

Łańcuchy rolkowe z zabierakami typu K2

Łańcuchy do celów transportowych

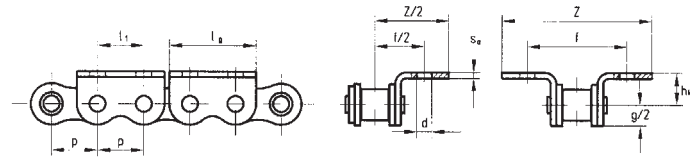

płytki wewnętrzne
płytki zewnętrzne
wymiar orientacyjny

DIN ISO	h_K [mm]	d [mm]	s_i [mm]	s_a [mm]	$g/2$ [mm]	l_g [mm]	l_1 [mm]	f [mm]	Z [mm]
---------	------------	----------	------------	------------	------------	------------	------------	----------	----------

Standard

04	110 11 58	110 37 66	4,50	2,30	0,57	0,57	2,50	11,10	6,00	11,20	17,60	WN*
05 B	110 11 11	110 01 23	5,30	2,30	0,73	0,73	3,40	14,80	8,00	13,50	21,50	WN
06 B	110 02 62	110 02 58	6,70	3,30	1,25	1,00	4,00	17,60	9,50	19,60	28,50	WN
08 B	111 37 72	111 37 73	8,90	4,30	1,50	1,50	5,80	24,40	12,70	25,40	41,70	DIN
08 B	110 05 23	110 05 19	8,50	4,30	1,50	1,50	5,80	24,40	12,70	27,60	41,90	WN
10 B	111 07 65	110 07 61	10,30	5,30	1,50	1,50	7,30	29,90	15,90	31,80	49,60	DIN
12 B	111 37 96	111 37 97	13,50	6,60	1,76	1,76	8,10	35,40	19,00	38,10	52,70	DIN
12 B	110 09 78	110 09 74	12,20	6,40	1,76	1,76	8,10	35,40	19,00	35,20	54,60	WN
16 B	111 37 40	111 37 41	15,90	6,60	3,70	3,00	10,30	46,20	25,40	50,80	85,60	DIN
16 B	110 15 81	110 15 77	17,00	8,40	3,70	3,00	10,00	45,40	25,40	58,00	83,80	WN
20 B	111 38 08	111 38 09	19,90	8,40	4,40	3,50	12,50	57,00	31,70	63,50	100,00	DIN
20 B	110 17 99	110 17 95	21,00	10,40	4,40	4,10	12,50	57,00	31,70	69,00	98,70	WN
24 B	110 19 09	110 19 05	28,00	10,50	5,40	5,00	16,70	71,50	38,10	88,00	124,70	WN

płytki wewnętrzne płytki zewnętrzne wymiar orientacyjny

08 A	110 68 12	110 22 76	7,90	3,30	1,50	1,50	5,50	24,00	12,70	25,40	35,80	DIN
10 A	110 65 48	110 65 49	10,30	5,30	2,00	2,00	7,20	29,90	15,80	31,80	49,80	DIN
12 A	110 76 53	110 26 94	11,90	5,30	2,40	2,40	8,60	35,60	19,00	38,10	58,00	DIN
16 A	111 31 11	111 37 29	15,90	6,60	3,00	3,00	10,30	46,20	25,40	50,80	82,60	DIN

Norma zakładowa

1351	110 92 34	110 92 35	8,00	3,30	1,00	1,00	4,80	22,50	12,70	20,60	31,60	WN
1352	110 92 34	110 92 35	8,00	3,30	1,00	1,00	4,80	22,50	12,70	22,20	33,20	WN
1202	110 63 01	110 05 71	8,00	4,30	1,50	1,50	5,30	23,40	12,70	21,40	33,60	WN
1203	110 63 01	110 05 71	8,00	4,30	1,50	1,50	5,30	23,40	12,70	23,00	35,20	WN
1622	110 07 65	110 07 61	10,30	5,30	1,50	1,50	7,30	29,90	15,90	28,40	45,30	WN

Łańcuchy o podwójnej podziałce

208 B	110 43 43	110 43 39	8,50	4,30	1,50	1,50	5,80	37,10	12,70	27,50	42,50	WN
210 B	110 43 89	110 43 85	10,50	5,30	1,50	1,50	7,30	46,70	15,80	31,60	48,50	WN
212 B	110 12 50	110 12 46	12,20	6,40	1,76	1,76	8,00	54,40	19,00	35,20	54,80	WN
216 B	110 16 64	110 16 60	17,00	8,40	3,70	3,00	10,30	71,30	25,40	58,00	83,80	WN
220 B	111 20 12	111 20 13	21,00	10,50	4,40	4,10	11,30	86,50	31,70	69,00	98,70	WN

208 A	110 08 41	110 08 72	9,10	3,30	1,50	1,50	5,70	23,80	9,50	25,40	40,60	WN
210 A	110 76 24	110 76 29	11,10	5,30	2,00	2,00	7,40	25,40	11,90	31,80	48,90	WN
212 A	110 76 79	110 76 83	14,70	5,30	2,40	2,40	8,80	28,60	14,30	42,80	58,00	WN

Wymiary łańcucha bazowego patrz str. 8

* WN = norma zakładowa, uwzględnić różnice wymiarowe

płytki wewnętrzne
płytki zewnętrzne
wymiar orientacyjny

DIN ISO	h_K [mm]	d [mm]	s_i [mm]	s_a [mm]	$g/2$ [mm]	l_g [mm]	l_1 [mm]	f [mm]	Z [mm]
---------	------------	----------	------------	------------	------------	------------	------------	----------	----------

Łańcuchy ze stali nierdzewnej Coris®

06 B	111 68 61	111 62 44	6,70	3,30	1,21	1,00	4,10	17,60	9,50	19,60	28,50	WN*
08 B	111 54 44	111 53 45	8,90	4,50	1,50	1,50	5,90	24,40	12,70	25,40	41,50	WN
10 B	111 54 57	111 54 26	10,30	5,50	1,50	1,50	7,30	29,90	15,80	31,80	49,60	WN
12 B	111 67 34	111 57 54	13,50	6,60	1,76	1,76	8,10	35,40	19,00	38,10	52,70	WN
16 B	111 59 92	111 58 24	15,90	6,60	3,76	3,00	10,40	46,20	25,40	50,80	85,60	WN

08 A	111 60 95	111 55 64	7,90	4,50	1,50	1,50	5,60	24,00	12,70	25,40	35,80	WN
10 A	-	111 54 89	10,30	5,50	2,00	2,00	7,30	29,90	15,80	31,80	51,40	WN
12 A	-	111 56 38	11,90	5,50	2,40	2,40	8,80	35,60	19,00	38,10	54,70	WN
16 A	-	111 57 95	15,90	6,60	3,00	3,00	10,50	48,20	25,40	50,80	82,00	WN

Łańcuchy niewymagające konserwacji „Syno“

08 B	111 67 78	111 67 29	8,90	4,50	1,50	1,50	5,90	24,40	12,70	25,40	41,80	WN
10 B	-	111 66 50	10,30	5,50	2,00	2,00	7,30	29,90	15,80	31,80	49,80	WN
12 B	111 69 00	111 67 20	13,50	6,60	2,40	2,40	8,40	35,60	19,00	38,10	56,20	WN
16 B	111 72 54	111 72 55	15,90	6,60	3,70	3,00	10,40	46,20	25,40	50,80	85,60	WN

08 A	-	111 66 59	7,90	4,50	1,50	1,50	5,90	24,00	12,70	25,60	36,00	WN
10 A	-	111 66 50	10,30	5,50	2,00	2,00	7,30	29,90	15,80	31,80	49,80	WN
12 A	111 69 32	111 69 33	11,90	6,60	2,40	2,40	8,40	35,60	19,00	38,10	54,60	WN
16 A	-	111 72 55	15,90	6,60	3,70	3,00	10,40	46,20	25,40	50,80	85,60	WN

* WN = norma zakładowa, uwzględnić różnice wymiarowe



Łańcuchy rolkowe z przedłużonymi sworzniami

Łańcuchy do celów transportowych

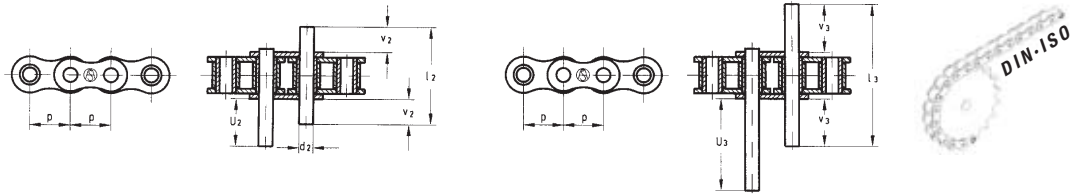

DIN Nr	Sworznie	d ₂ [mm]	l ₂ [mm]	U ₂ [mm]	v ₂ [mm]	d ₃ [mm]	l ₃ [mm]	U ₃ [mm]	v ₃ [mm]
--------	----------	---------------------	---------------------	---------------------	---------------------	---------------------	---------------------	---------------------	---------------------

Standard

04	110 00 59 110 00 64	1,85	12,50	6,30	3,50	1,85	18,00	11,80	6,20
05 B-1	110 74 22 110 01 21	2,31	13,60	6,40	3,60	2,31	19,10	11,90	6,30
06 B-1	110 02 70 110 02 76	3,28	23,00	11,30	6,10	3,28	33,30	21,60	11,20
08 B-1	110 58 79 110 59 15	4,45	30,40	14,80	7,90	4,45	44,30	28,70	14,80
10 B-1	110 59 38 110 65 55	5,08	35,40	17,60	9,30	5,08	52,00	34,20	17,60
12 B-1	110 59 57 110 59 70	5,72	41,40	20,70	10,90	5,72	60,90	40,20	20,70
16 B-1	110 15 90 110 16 08	8,28	66,80	33,30	17,40	8,28	98,70	65,20	33,30
20 B-1	110 18 07 110 18 23	10,19	77,90	38,30	20,00	10,19	114,40	74,80	38,30
24 B-1	110 19 34 110 19 35	14,63	101,00	50,40	26,20	14,63	149,40	98,80	50,40



08 A-1	110 23 00 110 34 00 111 38 69	3,96	30,80	15,20	8,00	3,96	45,10	29,50	15,20	ANSI
10 A-1	110 24 90 110 25 06 111 38 70	5,08	38,40	19,00	10,10	5,08	56,50	37,10	19,10	ANSI
12 A-1	110 27 18 110 27 35 111 38 71	5,94	48,10	24,00	12,60	5,94	70,90	46,80	24,00	ANSI
16 A-1	110 29 15 110 29 32 111 38 72	7,92	61,30	30,80	16,10	7,92	90,60	60,10	30,70	ANSI

Łańcuchy ze stali nierdzewnej „Coris“

06 B-1	111 60 26	3,28	23,00	11,30	6,10
08 B-1	111 52 49	4,45	30,40	14,80	7,90
10 B-1	111 53 59	5,08	35,40	17,60	9,30
12 B-1	111 53 65	5,72	41,40	20,70	10,90
16 B-1	111 53 71	8,28	66,80	33,30	17,40

08 A-1	111 78 81	3,96	32,30	15,20	8,10
10 A-1	111 61 13	5,08	38,40	19,00	10,10
12 A-1	111 78 31	5,94	48,10	23,90	12,60
16 A-1	111 60 78	7,92	61,30	30,80	16,10

Łańcuchy niewymagające konserwacji „Syno“

08 B-1	111 63 01	3,97	30,80	14,80	7,90
10 B-1	111 73 64	4,45	37,00	17,50	9,20
12 B-1	111 67 11	5,08	44,80	20,60	10,90
16 B-1	111 64 10	7,00	66,80	33,30	17,40

Wymiary łańcucha bazowego patrz str. 8

Łańcuchy z nakładką typu U

Łańcuchy do celów transportowych

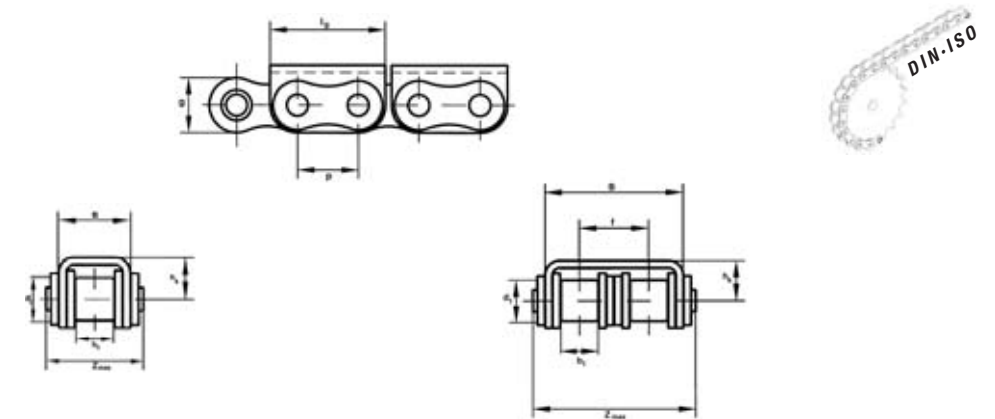
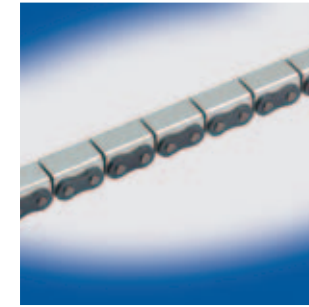

Podobny A&S DIN Nr	Nr Nr	Nr zam.	p x b ₁	p [mm]	b ₁ [mm]	d ₁ [mm]	g [mm]	h _K [mm]	B [mm]	l _g [mm]	f [mm]	Z [mm]	F _{bmin} [N]
-----------------------	----------	------------	--------------------	-----------	------------------------	------------------------	-----------	------------------------	-----------	------------------------	-----------	-----------	--------------------------

08B-1	1603	120 05 64	1/2" x 5/16"	12,70	7,75	8,51	11,80	8,3	14,5	24,2	19,8	19 000	
08B-2	1603-2	120 26 87	1/2" x 5/16"	12,70	7,75	8,51	11,80	8,3	28,4	24,2	13,92	33,5	32 000
08B-3	1603-3	120 86 81	1/2" x 5/16"	12,70	7,75	8,51	11,80	10,0	43,5	24,2	13,92	51,5	47 500
10B-1	1623	121 29 68	5/8" x 3/8"	15,875	9,65	10,16	14,70	12,0	16,56	30,0	22,6	24 000	
10B-2	1623-2	120 86 83	5/8" x 3/8"	15,875	9,65	10,16	14,70	10,5	33,2	30,0	16,59	38,4	46 800
12B-1	1642	120 38 62	3/4" x 7/16"	19,05	11,68	12,07	16,10	13,0	19,6	35,6	25,7	30 500	
12B-2	1642-2	120 33 61	3/4" x 7/16"	19,05	11,68	12,07	16,10	12,0	39,1	37,0	19,46	45,3	59 000
16B-1	1666	121 02 06	1" x 0,67"	25,40	17,02	15,88	21,00	15,4	30,0	49,0	39,3	65 000	
20B-1	1682	120 86 22	1 1/4" x 3/4"	31,75	19,56	19,05	26,40	21,0	36,0	57,0	48,0	95 000	
24B-1	1702	120 59 42	1 1/2" x 1"	38,10	25,40	25,40	33,40	28,0	46,9	72,6	61,6	160 000	



16A-1	80	120 18 46	1" x 5/8"	25,40	15,75	15,88	24,10	15,4	27,2	49,0	36,5	56 700	
16A-2	80-2	120 30 85	1" x 5/8"	25,40	15,75	15,88	24,10	15,4	27,2	49,0	33,8	70,6	75 600

Wymiary łańcucha bazowego patrz str. 8

Łańcuchy z nakładką polimerową - 2K

Łańcuchy do celów transportowych

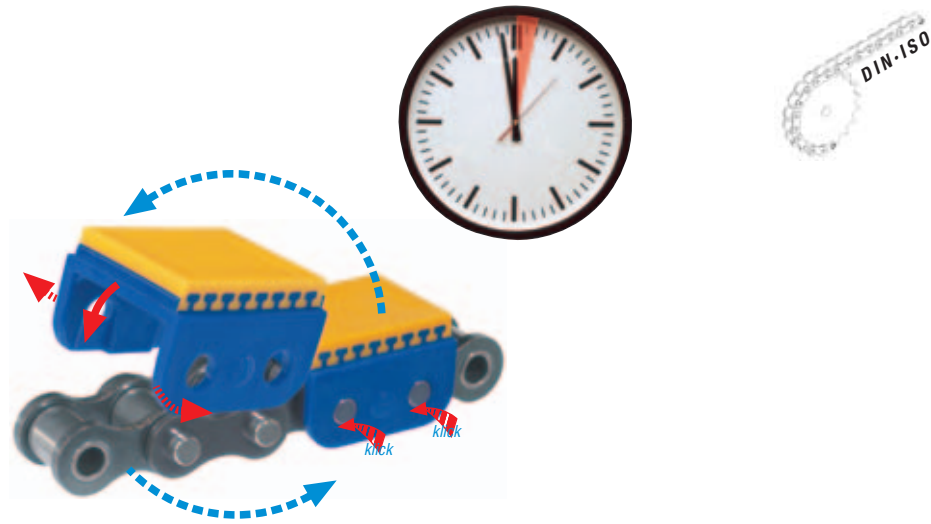

sila zrywająca

Podobny DIN Nr	A&S Nr	p x b ₁	Nr zam.	F _b min [N]
-------------------	-----------	--------------------	---------	---------------------------

Łańcuch bazy 1603 (08B-1)

08B-1	1603	1/2" x 5/16"	121 03 13	19 000
-------	------	--------------	-----------	--------

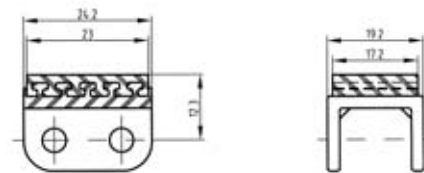

Łańcuch bazy 1642 (12B-1)

12B-1	1642	3/4" x 7/16"	121 03 17	30 500
-------	------	--------------	-----------	--------

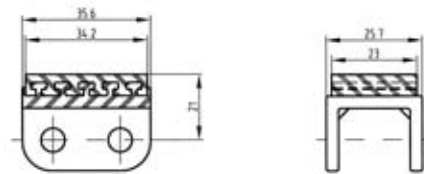

Łańcuch bazy 1666 (16B-1)

16B-1	1666	1" x 0,67"	120 97 54	65 000
-------	------	------------	-----------	--------

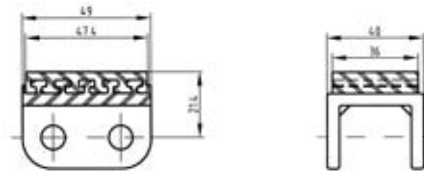

Zastosowania

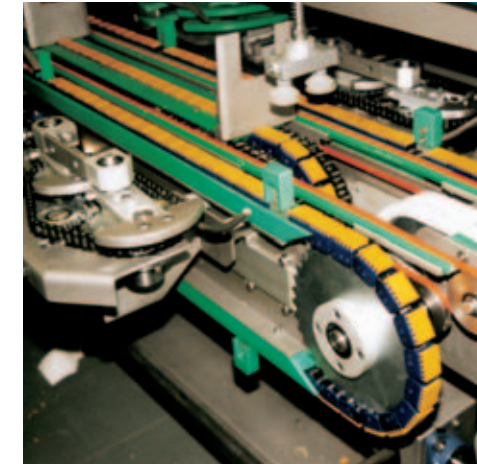

Materiał	TPU Elastollan
Twardość Shore A	75 ± 5
Ścieralność DIN 53516 [mm ³]	160
Temperatura min.	-10°C
Temperatura max.	+70°C
Odporność na ścieranie	2
Odporność na starzenie materiału	1
Odporność na tłuszcz i olej	1
Kolor	

Ocena: 1 = wybitna, 2 =bardzo dobra, 3 =dobra, 4 = odpowiednia, 5 = zła, 6 = nieodpowiednia

Łańcuch bazy także w wersji nierdzewnej.



Łańcuchy z nakładką polimerową

Łańcuchy do celów transportowych

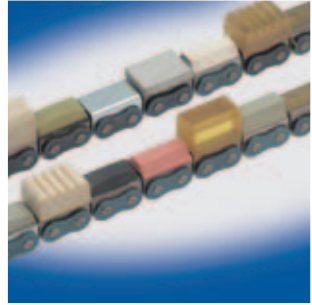

Materiał	NR Kauczuk naturalny	NBR Kauczuk akrylowo-nitrylowy	PUR Poliuretan
Twardość Shore A	65 ± 5	75 ± 5	85 ± 5
Ścieralność DIN 53516 [mm³]	160	160	80
Temperatura min.	-10°C	-10°C	-10°C
Temperatura max.	+90°C	+120°C	+80°C
Odporność na ścieranie	2	2	1
Odporność na starzenie materiału	3	3	1
Odporność na tłuszcz i olej	6	1	2
Kolor			
Ocena:			

Ocena: 1 = wybitna, 2 = bardzo dobra, 3 = dobra, 4 = odpowiednia, 5 = zła, 6 = nieodpowiednia

Podobny DIN/ISO	A&S Nr	p x b1	Nr zam. łańcuch			Nr zam. ogniwo łączące			Profil Nr
			NR	NBR	PUR	NR	NBR	PUR	
08B-1	1603	1/2"x5/16"	120 00 01	120 31 59	120 29 04	130 02 53	130 67 94	130 62 91	0520
08B-1	1603 SZ*	1/2"x5/16"	120 29 64		120 35 91	130 63 94		130 75 86	0520
08B-1	1603 SS**	1/2"x5/16"		120 98 51			131 73 15		0520
08B-1	1603	1/2"x5/16"	120 00 02		120 27 10	130 17 69		131 00 01	1870
08B-1	1603	1/2"x5/16"	120 07 71	120 33 45	120 27 29	130 26 39	130 70 86	130 77 11	2750
08B-1	1603	1/2"x5/16"	120 30 72	120 48 57		130 66 20	131 00 59		4740
08B-1	1603	1/2"x5/16"		120 42 52			130 89 23		5800
08B-1	1603 SS**	1/2"x5/16"		120 99 73			131 75 23		5800
08B-2	1603-2	1/2"x5/16"	120 00 12			130 17 76			0560
08B-2	1603-2	1/2"x5/16"	120 39 69	120 00 03	120 26 84	130 84 69	130 04 16	130 79 88	0530
08B-2	1603-2	1/2"x5/16"	120 00 04			130 17 70			0610
08B-2	1603-2	1/2"x5/16"	120 00 09		120 77 03	130 17 74		131 46 74	0590
08B-2	1603-2	1/2"x5/16"	120 00 06			130 17 72			0810
08B-2	1603-2	1/2"x5/16"	120 23 27			130 19 92			1360
08B-2	1603-2	1/2"x5/16"	120 00 14			130 38 46			0910
08B-2	1603-2	1/2"x5/16"	120 97 80			131 71 99			3180
08B-2	1603-2	1/2"x5/16"	120 00 13	120 61 12	120 33 83	130 17 77	131 21 94	130 71 76	0660
08B-2	1603-2	1/2"x5/16"	120 00 08			130 17 73			0820
08B-2	1603-2 SZ*	1/2"x5/16"	120 77 58	120 99 92		131 47 06	131 75 47		0820
08B-2	1603-2	1/2"x5/16"	120 00 10			130 4 203			1760
08B-2	1603-2	1/2"x5/16"		120 48 58			131 00 60		2020
08B-2	1603-2	1/2"x5/16"		120 64 95			131 28 58		2520
08B-2	1603-2	1/2"x5/16"	120 00 11			130 17 75			0540
12B-1	1642	3/4"x7/16"	120 00 60	120 62 06		130 77 12	131 23 57		4680
12B-1	1642 SZ*	3/4"x7/16"		120 83 60			131 54 34		4680
12B-1	1642 SS**	3/4"x7/16"		120 98 75			131 73 74		4680
12B-1	1642	3/4"x7/16"	120 40 34			130 85 91			5350
12B-2	1642-2	3/4"x7/16"	120 00 16	120 60 78		130 03 05	131 20 79		0630
12B-2	1642-2	3/4"x7/16"	120 20 32	120 52 37	120 56 81	130 77 14	131 07 29	131 14 73	0760
12B-2	1642-2 SZ*	3/4"x7/16"	120 31 35			130 77 15			0760
12B-2	1642-2	3/4"x7/16"	120 63 10			131 25 68			1480
16B-1	1666	1" x 0.67"		120 96 83			131 70 41		6570
20B-1	1682	1 1/4"x3/4"		120 89 51			131 68 59		2160
24B-1	1702	1 1/2" x 1"	120 33 00	120 67 99		130 70 19	131 33 79		0830
16A-1	80	1" x 5/8"	120 00 17			130 00 25			0570
16A-1	80	1" x 5/8"		120 40 72			130 86 49		0570
16A-1	80 SZ*	1" x 5/8"		120 91 81			131 65 13		0570
16A-1	80	1" x 5/8"		121 01 83			131 78 19		0570
16A-1	80	1" x 5/8"		121 25 71			132 01 91		1300
16A-1	80	1" x 5/8"		120 65 04			131 64 19		1310

* ocynkowane, chromowane

** Stal kwasoodporna

Profil Nr 0520

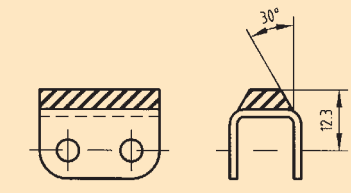

Profil Nr 0540

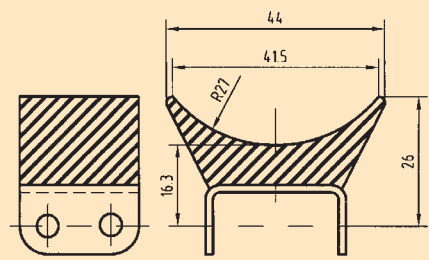

Profil Nr 0570

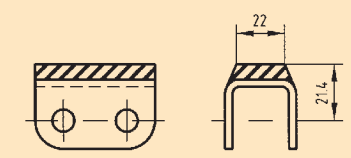

Profil Nr 0610

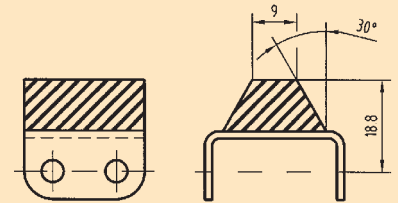

Profil Nr 0660

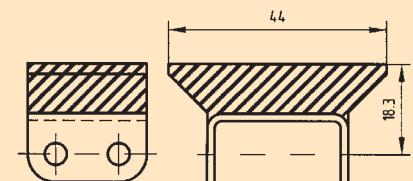

Profil Nr 0530

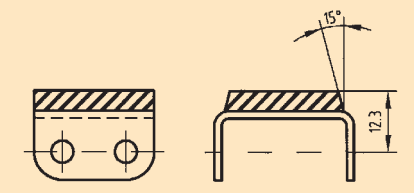

Profil Nr 0560

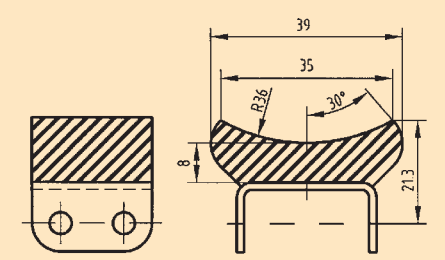

Profil Nr 0590

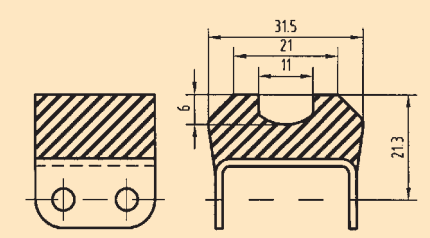

Profil Nr 0630

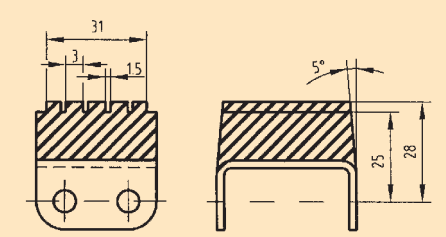

Profil Nr 0760

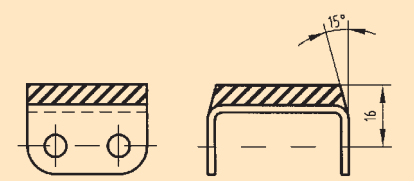

Łańcuchy z nakładką polimerową

Łańcuchy do celów transportowych

Profil Nr 0810

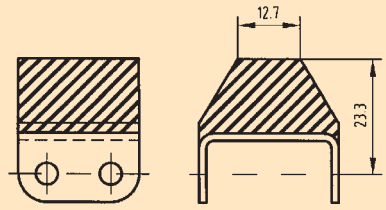

Profil Nr 0830

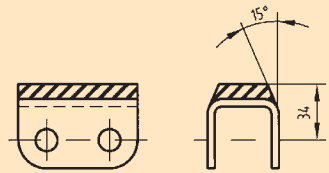

Profil Nr 1300

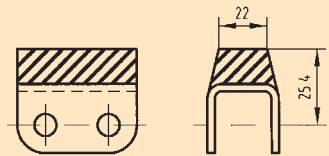

Profil Nr 1360



Profil Nr 1760

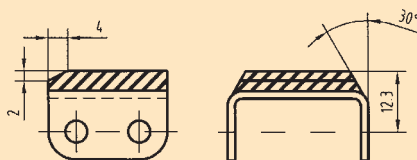

Profil Nr 0820

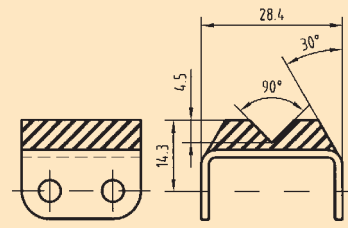

Profil Nr 0910

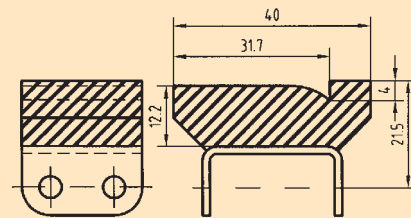

Profil Nr 1310

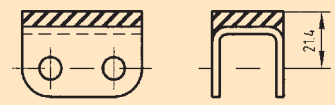

Profil Nr 1480

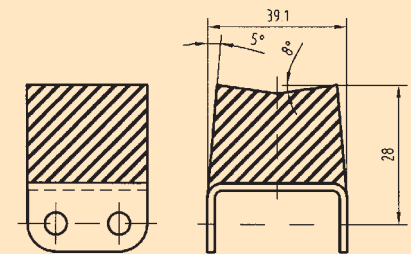

Profil Nr 1870

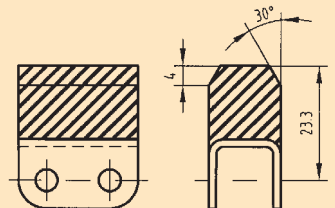

Profil Nr 2020

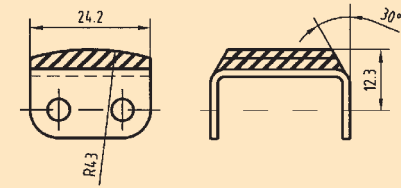

Profil Nr 2520

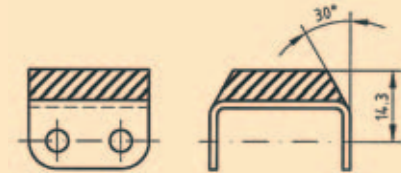

Profil Nr 3180

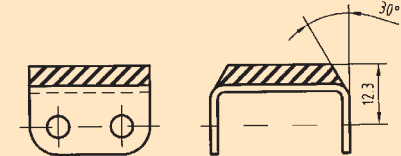

Profil Nr 4740

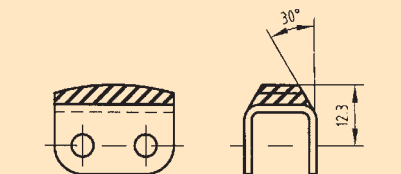

Profil Nr 5800

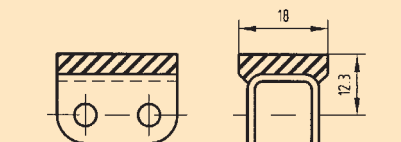

Profil Nr 2160

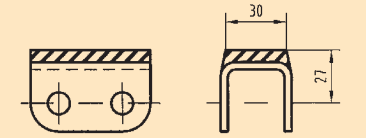

Profil Nr 2750

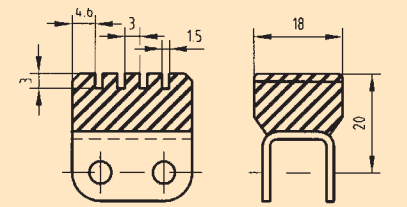

Profil Nr 4680

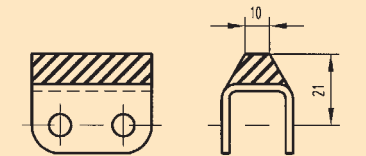

Profil Nr 5350

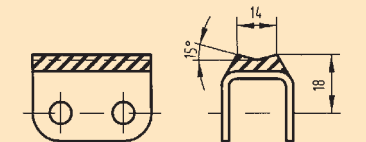

Profil Nr 6570

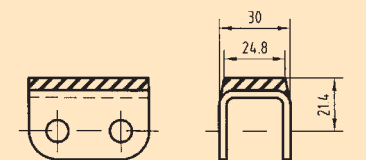



Łańcuchy z pustymi sworzniami

Łańcuchy do celów transportowych

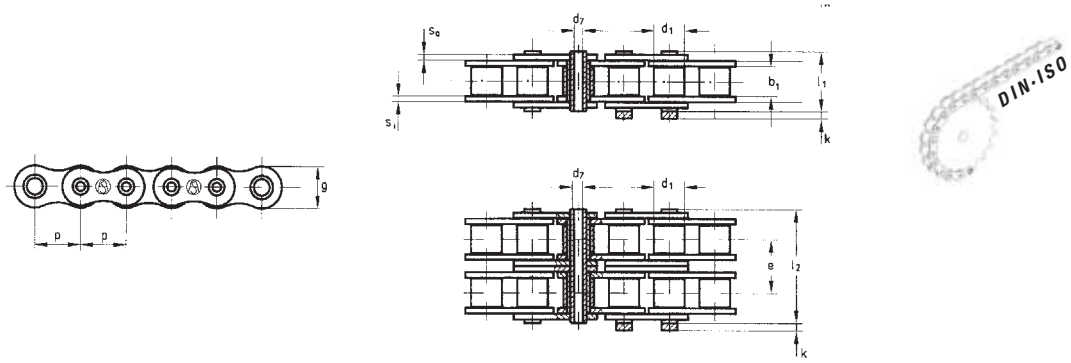
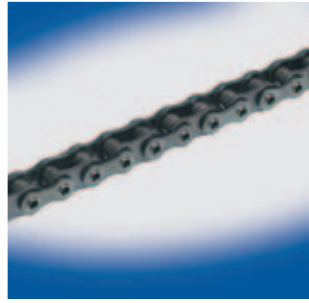

podziałka
min. szerokość wewnętrzna
max. średnica rolki
max. wysokość płytki
grubość płytki wewnętrznej
grubość płytki zewnętrznej

max. długość sworznia
max. długość spinki
długość osi
siła zrywająca
waga

A&S Nr	Nr zam.	p x b ₁	p	b ₁ min	d ₁ max	g max	s _i [mm]	s _a [mm]	d ₇ min [mm]	l _{1,2} max [mm]	k max [mm]	e max [mm]	F _b min [N]	q [kg/m]	Nr DIN	4 (B)	7 (A)	26S (E)	58 (S)
--------	---------	--------------------	---	--------------------	--------------------	-------	---------------------	---------------------	-------------------------	---------------------------	------------	------------	------------------------	----------	--------	-------	-------	---------	--------

Łańcuchy z pustymi sworzniami w wykonaniu rolkowym

1665-V	120 36 29	1" x 1/2"	25,40	12,70	15,88	23,00	4,00	3,00	7,05	30,80	1,30		40 000	2,20	•	•	•		
1665-V-2	120 43 30	1" x 1/2"	25,40	12,70	15,88	23,00	4,00	3,00	7,05	64,20	1,30	27,70	80 000	4,32	•	•	•		
1702-HB	120 48 91	1 1/2" x 1"	38,10	25,40	25,40	33,50	5,40	5,00	10,20	52,60	0,40		120 000	5,85	•	•	•		
262-HB	100 08 84	2" x 10	50,80	10,00	30,00*	25,50	3,00	3,00	8,20	26,00	4,00		60 000	2,10	•	•	•		
263-HB	100 09 48	100 x 10	100,00	10,00	30,00*	25,50	3,00	3,00	8,20	26,00	4,00		60 000	1,50	•	•	•		

*rolka jezdna

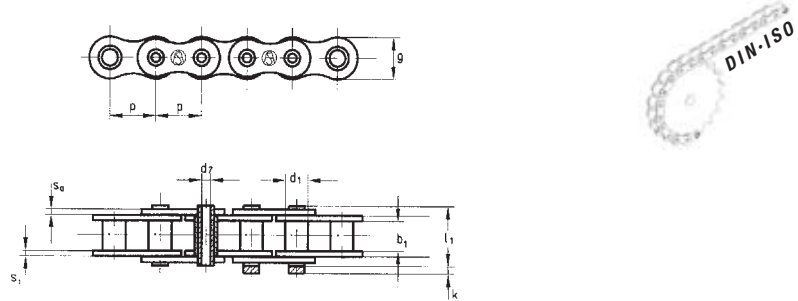
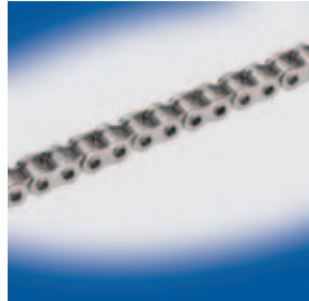

podziałka
min. szerokość wewnętrzna
max. średnica rolki
max. wysokość płytki
grubość płytki wewnętrznej
grubość płytki zewnętrznej

max. długość sworznia
max. długość spinki
długość osi
siła zrywająca
waga

A&S Nr	Nr zam.	p x b ₁	p	b ₁ min	d ₁ max	g max	s _i [mm]	s _a [mm]	d ₇ min [mm]	l _{1,2} max [mm]	k max [mm]	e max [mm]	F _b min [N]	q [kg/m]	Nr DIN	4 (B)	7 (A)	26S (E)	58 (S)
--------	---------	--------------------	---	--------------------	--------------------	-------	---------------------	---------------------	-------------------------	---------------------------	------------	------------	------------------------	----------	--------	-------	-------	---------	--------

Łańcuchy z pustymi sworzniami w wykonaniu tulejkowym

1270-B	120 43 87	1/2" x 5/16"	12,70	7,75	8,51	12,10	1,50	1,50	4,50	16,50	1,10		12 000	0,66	•	•	•		
1270-B SS	120 67 42	1/2" x 5/16"	12,70	7,75	8,51	12,10	1,50	1,50	4,50	16,50	1,10		9 000	0,66	•	•	•		
50-HB	120 60 40	5/8" x 3/8"	15,875	9,40	10,16	15,10	2,00	2,00	5,10	20,40	1,00		18 000	1,05	•	•	•		
60-HB	120 54 48	3/4" x 1/2"	19,05	12,57	11,91	17,40	2,40	2,40	6,00	25,80	1,30		28 500	1,39	•	•	•		

SS = łańcuchy ze stali nierdzewnej „Coris“

Łańcuchy do pracy po łuku

Łańcuchy do celów transportowych

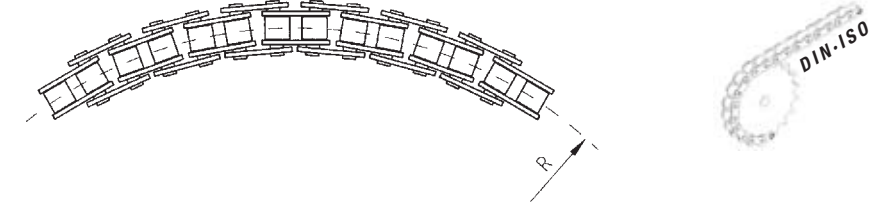

podziałka
min. szerokość wewnętrzna
max. średnica rolki

max. wystająca część sworznia
promień ugięcia łańcucha
siła zrywająca
waga

A&S Nr	Nr zam.	p	b ₁ min	d ₁ max	d ₂ h9 [mm]	l ₁ max [ć]	k max [mm]	R min [mm]	F _b min [mm]	q [kg/m]	Nr DIN	4 (B)	7 (A)	26 (E)	58 (S)
--------	---------	---	--------------------	--------------------	------------------------	------------------------	------------	------------	-------------------------	----------	--------	-------	-------	--------	--------

Łańcuchy do pracy po łuku

2191SB*	120 22 19	9,525	5,72	6,35	3,28	12,50	3,30	195	9 000	0,39	•	•	•		
40 SB	120 60 46	12,7	7,85	7,95	3,42	16,50	3,90	350	13 000	0,58	•	•	•		
1202 SB	120 01 79	12,7	4,88	7,75	3,65	14,00	2,60	280	15 000	0,52	•	•	•		
1603 SB	120 53 19	12,7	7,75	8,51	4,45	17,70	3,90	400	18 200	0,69	•	•	•		
1623 SB	120 01 80	15,875	9,65	10,16	4,70	18,80	4,10	450	22 700	0,85	•	•	•		
1642 SB	120 18 71	19,05	11,68	12,07	5,72	21,90	4,60	650	29 500	1,18	•	•	•		
1666 SB	120 59 54	25,4	17,02	15,88	8,27	35,70	5,40	750	65 000	2,50	•	•	•		
C 2050 SB*	120 20 13	31,75	9,40	10,16	4,45	20,50	4,10	650	22 200	0,69	•	•	•	•	

*prostoliniowość płytki

tolerancja długości + 0,30%

Inne wymiary: patrz łańcuchy rolkowe wg. DIN 8187, 8188, 8181!

Łańcuchy akumulacyjne /transferowe

Łańcuchy do celów transportowych

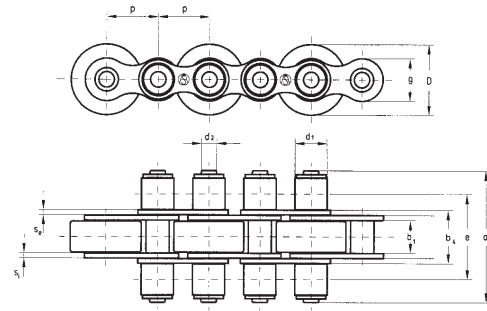

p: podziałka
 b₁: min. szerokość wewnętrzna
 b₂: max. szerokość wewnętrzna
 b₄: max. szerokość zewnętrzna
 d₁: max. średnica rolki
 d₂: min. średnica rolki
 a: odległość osi
 D: dopuszczalne obciążenie rolki
 e: materiał rolki
 F_D: siła zrywająca

A&S Nr	Nr zam.	p	b ₁ min	b ₂ max	b ₄ h9	d ₁ max	d ₂ min	a min	e	D	F _D min
		[mm]	[mm]	[mm]	[mm]	[mm]	[mm]	[mm]	[mm]	[N/Ro]	[N]

Typ A

1945	120 49 65	19,05	11,68	15,62	19,5	12,0	5,72	43,0	28,7	26,0	150	St	32 000
	120 49 59							43,0	28,7	26,0	100	PA12	32 000
	120 74 52							48,1	31,2	24,0	150	St	32 000
	120 69 08							48,1	31,2	24,0	100	PA 6.6	32 000
	120 75 16							48,1	31,2	26,0	150	St	32 000
	120 69 09							48,1	31,2	26,0	100	PA 6.6	32 000

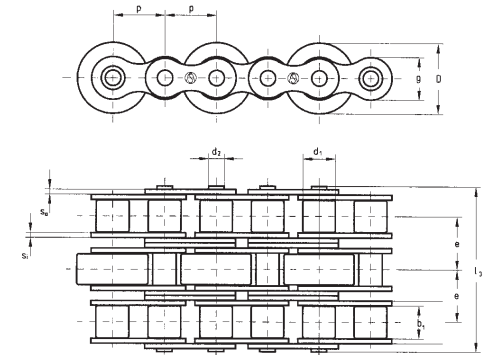

p: podziałka
 b₁: min. szerokość wewnętrzna
 b₂: max. szerokość wewnętrzna
 b₄: max. szerokość zewnętrzna
 d₁: max. średnica rolki
 d₂: min. średnica rolki
 l₃: min. odległość osi
 e: dopuszczalne obciążenie rolki
 D: materiał rolki
 F_D: siła zrywająca

A&S Nr	Nr zam.	p	b ₁ min	b ₂ max	d ₁ max	d ₂ min	l ₃ min	e	D	F _D min
		[mm]	[mm]	[mm]	[mm]	[mm]	[mm]	[mm]	[N/Ro]	[N]

Typ C

1945-3	120 67 80	19,05	11,68	15,62	12,07	5,72	60,9	19,46	24,0	150	St	88 500
	120 75 26	19,05	11,68	15,62	12,07	5,72	60,9	19,46	24,0	100	PA 6.6	88 500

St = stal stopowa hartowana PA 6.6 = Poliamid 6.6 PA 12 = Poliamid 12 antystatyczna

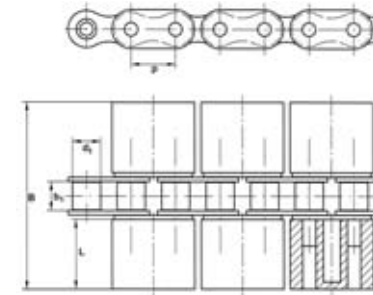
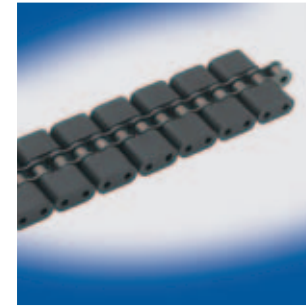

p: podziałka
 b₁: min. szerokość wewnętrzna
 d₁: max. średnica rolki
 F_b: siła zrywająca
 L: śliskość materiału
 B: powierzchnia wsparcia
 ogniwa zewnętrznego: powierzchnia wsparcia na metr

DIN Nr	Nr zam.	p	b ₁	d ₁	F _b min	L min	B	ogniwa zewnętrznego	na metr
		[mm]	[mm]	[mm]	[c]	[mm]	[mm]	[cm ²]	[cm ²]

Łańcuchy transferowe

06B-1	121 13 77	9,525	5,72	6,35	9 100	11,3	33,4	2,15	112,9
06B-1	121 13 78	9,525	5,72	6,35	9 100	14,6	40,0	2,78	145,0
08B-1	121 04 31	12,70	7,75	8,51	19 000	9,40	33,4	2,43	94,6
08B-1	121 04 32	12,70	7,75	8,51	19 000	12,70	40	3,28	127,8
08B-1	121 04 33	12,70	7,75	8,51	19 000	17,70	50	4,57	178,1

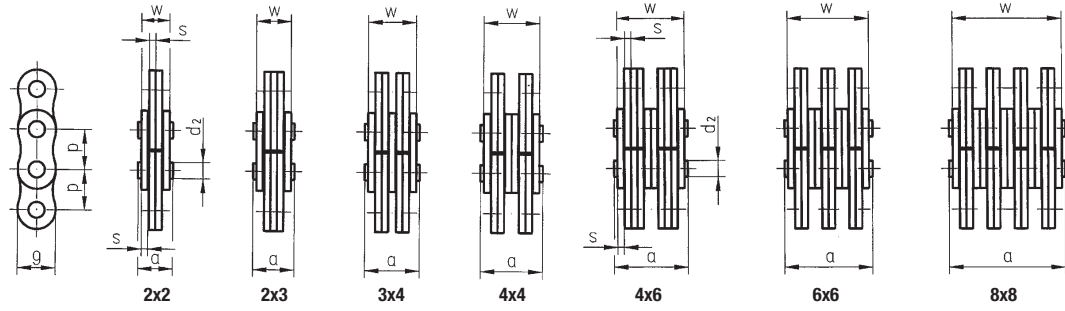
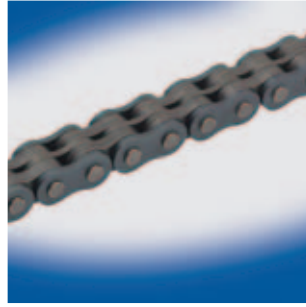

Podziałka
układ płytek
max. wysokość płytki
grubość płytki
max. średnica sworznia
max. długość sworznia
szerokość płytek
siła zrywająca
średnia siła zrywająca
Waga

DIN Nr	ANSI Nr zam.	Nr zam.	p [mm]	g [mm]	s max [mm]	d ₂ [mm]	a [mm]	w max [mm]	F ₀ min [N]	F _m [N]	q [kg/m]
--------	--------------	---------	--------	--------	------------	---------------------	--------	------------	------------------------	--------------------	----------

Typ ciężki LH

DIN 8152-3 ISO 4347, ANSI B 29.8

LH 0822	BL 422	140 07 79	12,70	2 x 2	12,1	2,06	5,08	10,9	8,5	27 800	29 000	0,63
LH 0823	BL 423	140 07 02	12,70	2 x 3	12,1	2,06	5,08	13,0	10,6	27 800	29 000	0,78
LH 0834	BL 434	140 07 03	12,70	3 x 4	12,1	2,06	5,08	17,2	14,8	42 500	45 500	1,08
LH 0844	BL 444	140 07 04	12,70	4 x 4	12,1	2,06	5,08	19,3	16,9	58 000	59 000	1,23
LH 0846	BL 446	140 07 05	12,70	4 x 6	12,1	2,06	5,08	23,5	21,1	58 000	60 000	1,53
LH 0866	BL 466	140 07 06	12,70	6 x 6	12,1	2,06	5,08	27,8	25,4	90 000	93 000	1,83
LH 0888	BL 488	140 07 72	12,70	8 x 8	12,1	2,06	5,08	36,3	33,9	110 000	118 000	2,43
LH 1023	BL 523	140 07 07	15,875	2 x 3	15,1	2,46	5,95	15,0	12,4	40 100	45 000	1,18
LH 1034	BL 534	140 07 08	15,875	3 x 4	15,1	2,46	5,95	19,9	17,3	60 000	65 000	1,63
LH 1044	BL 544	140 07 09	15,875	4 x 4	15,1	2,46	5,95	22,4	19,8	78 000	91 000	1,86
LH 1046	BL 546	140 07 10	15,875	4 x 6	15,1	2,46	5,95	27,3	24,7	78 000	91 000	2,32
LH 1066	BL 566	140 07 11	15,875	6 x 6	15,1	2,46	5,95	32,3	29,7	120 000	137 000	2,77
LH 1088	BL 588	140 07 12	15,875	8 x 8	15,1	2,46	5,95	42,2	39,6	140 000	178 000	3,68
LH 1223	BL 623	140 07 13	19,05	2 x 3	18,2	3,23	7,93	20,0	16,6	60 000	69 000	1,92
LH 1234	BL 634	140 07 14	19,05	3 x 4	18,2	3,23	7,93	26,3	22,9	101 500	107 000	2,66
LH 1244	BL 644	140 07 15	19,05	4 x 4	18,2	3,23	7,93	29,6	26,2	126 000	141 000	3,03
LH 1246	BL 646	140 07 16	19,05	4 x 6	18,2	3,23	7,93	36,5	33,1	126 000	142 000	3,78
LH 1266	BL 666	140 07 17	19,05	6 x 6	18,2	3,23	7,93	43,0	39,6	190 000	210 000	4,52
LH 1288	BL 688	140 05 71	19,05	8 x 8	18,2	3,23	7,93	56,4	53,0	245 000	270 000	6,00
LH 1622	BL 822	140 07 18	25,40	2 x 2	24,0	4,06	9,53	20,1	16,5	93 000	104 000	2,40
LH 1623	BL 823	140 07 19	25,40	2 x 3	24,0	4,06	9,53	24,2	20,6	100 000	104 000	2,98
LH 1634	BL 834	140 07 20	25,40	3 x 4	24,0	4,06	9,53	32,6	29,0	152 000	165 000	4,14
LH 1644	BL 844	140 07 21	25,40	4 x 4	24,0	4,06	9,53	36,7	33,1	186 000	210 000	4,72
LH 1646	BL 846	140 07 22	25,40	4 x 6	24,0	4,06	9,53	45,0	41,4	186 000	208 000	5,88
LH 1666	BL 866	140 07 23	25,40	6 x 6	24,0	4,06	9,53	53,2	49,6	285 000	325 000	7,04
LH 1688	BL 888	140 07 73	25,40	8 x 8	24,0	4,06	9,53	69,8	66,2	338 000	400 000	9,37
LH 2022	BL 1022	140 07 74	31,75	2 x 2	29,6	4,88	11,1	23,8	19,8	118 000	145 000	3,57
LH 2023	BL 1023	140 07 24	31,75	2 x 3	29,6	4,88	11,1	28,7	24,7	142 000	145 000	4,44
LH 2034	BL 1034	140 07 25	31,75	3 x 4	29,6	4,88	11,1	38,6	34,6	244 000	250 000	6,17
LH 2044	BL 1044	140 07 26	31,75	4 x 4	29,6	4,88	11,1	43,6	39,6	284 000	303 000	7,04
LH 2046	BL 1046	140 07 27	31,75	4 x 6	29,6	4,88	11,1	53,5	49,5	305 500	310 000	8,78
LH 2066	BL 1066	140 07 28	31,75	6 x 6	29,6	4,88	11,1	63,4	59,4	417 000	450 000	10,52
LH 2088	BL 1088	140 07 75	31,75	8 x 8	29,6	4,88	11,1	83,2	79,2	462 000	600 000	13,99
LH 2434	BL 1234	140 06 88	38,10	3 x 4	35,9	5,68	12,71	45,1	40,7	245 000	305 000	9,25
LH 2446	BL 1246	140 06 89	38,10	4 x 6	35,9	5,68	12,71	62,5	58,1	371 500	405 000	13,16
LH 2466	BL 1266	140 06 90	38,10	6 x 6	35,9	5,68	12,71	74,2	69,8	454 000	560 000	15,77
LH 2488	BL 1288	140 07 81	38,10	8 x 8	35,9	5,68	12,71	97,4	93,0	605 000	650 000	20,98
LH 2834	BL 1434	140 05 59	44,45	3 x 4	41,9	6,38	14,28	51,2	46,2	316 000	380 000	12,14
LH 2846	BL 1446	140 05 57	44,45	4 x 6	41,9	6,38	14,28	71,0	66,0	427 500	510 000	17,28
LH 3234	BL 1634	140 06 46	50,80	3 x 4	47,8	7,18	17,46	58,5	52,5	530 000	560 000	15,67
LH 3244	BL 1644	140 06 91	50,80	4 x 4	47,8	7,18	17,46	66,0	60,0	579 000	690 000	17,87
LH 3246	BL 1646	140 06 47	50,80	4 x 6	47,8	7,18	17,46	81,0	75,0	579 000	690 000	22,29
LH 3266	BL 1666	140 06 92	50,80	6 x 6	47,8	7,18	17,46	96,0	90,0	868 000	1 000 000	26,70
LH 3288	BL 1688	140 06 48	50,80	8 x 8	47,8	7,18	17,46	126,0	120,0	1 157 000	1 300 000	35,53

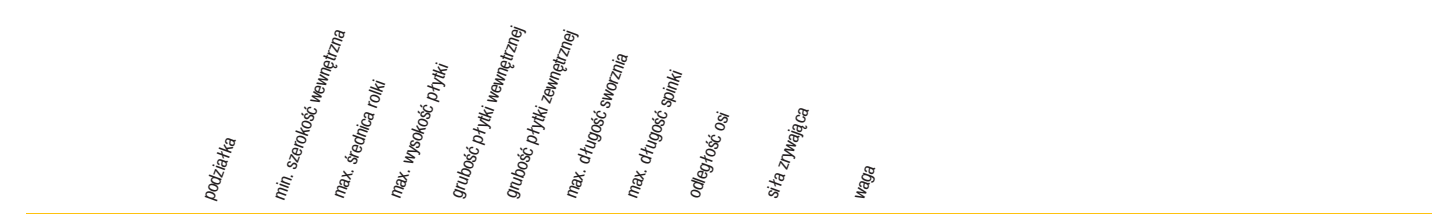

DIN Nr	Nr zam.	p [mm]	100 x p [mm]	g [mm]	s max [mm]	d ₂ [mm]	a [mm]	w max [mm]	F ₀ min [N]	F _m [N]	q [kg/m]
--------	---------	--------	--------------	--------	------------	---------------------	--------	------------	------------------------	--------------------	----------

Typ lekki LL

DIN 8152-1 ISO 4347

LL 0822	140 00 21	12,70	1259	2 x 2	10,7	1,69	4,45	8,9	7,0	21 000	22 500	0,44
LL 0844	140 00 24	12,70	1259	4 x 4	10,7	1,69	4,45	15,9	14,0	42 000	45 000	0,87
LL 0866	140 00 27	12,70	1259	6 x 6	10,7	1,69	4,45	22,8	21,0	64 000	67 000	1,30
LL 1022	140 03 69	15,875	1577	2 x 2	12,8	1,55	5,08	8,9	6,7	22 700	24 000	0,47
LL 1044	140 03 70	15,875	1577	4 x 4	12,8	1,55	5,08	15,6	13,4	45 400	50 000	0,92
LL 1066	140 03 71	15,875	1577	6 x 6	12,8	1,55	5,08	22,2	20,0	68 100	74 000	1,36
LL 1222	140 03 72	19,05	1892	2 x 2	14,8	1,81	5,72	10,0	7,6	32 000	37 500	0,62
LL 1244	140 03 73	19,05	1892	4 x 4	14,8	1,81	5,72	17,8	15,4	64 000	75 000	1,21
LL 1266	140 03 74	19,05	1892	6 x 6	14,8	1,81	5,72	24,8	22,4	96 000	112 000	1,79
LL 1622	140 00 57	25,40	2532	2 x 2	20,2	3,06	8,27	15,5	12,5	72 000	78 000	1,42
LL 1644	140 00 60	25,40	2532	4 x 4	20,2	3,06	8,27	28,1	25,1	144 000	155 000	2,79
LL 1666	140 00 63	25,40	2532	6 x 6	20,2	3,06	8,27	40,5	37,3	216 000	230 000	4,15
LL 2022	140 03 75	31,75	3157	2 x 2	25,3	3,56	10,17	18,2	14,9	95 000	110 000	2,03
LL 2044	140 03 76	31,75	3157	4 x 4	25,3	3,56	10,17	33,4	30,1	190 000	220 000	4,00
LL 2066	140 03 77	31,75	3157	6 x 6	25,3	3,56	10,17	47,9	44,3	285 000	330 000	5,96
LL 2422	140 03 78	38,10	3797	2 x 2	30,7	5,08	14,63	25,4	21,4	170 000	172 000	3,60
LL 2444	140 03 79	38,10	3797	4 x 4	30,7	5,08	14,63	46,8	42,8	340 000	345 000	7,07
LL 2466	140 03 80	38,10	3797	6 x 6	30,7	5,08	14,63	68,2	64,2	510 000	510 000	10,53

Typ AL

ANSI B 29.8

AL 422	140 04 64	12,70	1257	2 x 2	9,7	1,55	3,97	8,0	6,4	17 000	19 500	0,35
AL 444	140 04 65	12,70	1257	4 x 4	9,7	1,55	3,97	14,8	12,8	34 000	38 500	0,68
AL 466	140 04 66	12,70	1257	6 x 6	9,7	1,55	3,97	21,1	19,2	51 000	57 000	1,01
AL 544	140 03 96	15,875	1578	4 x 4	12,7	2,06	5,08	18,8	16,8	58 000	64 000	1,20
AL 566	140 03 97	15,875	1578	6 x 6	12,7	2,06	5,08	27,2	25,2	90 000	91 500	1,79
AL 622	140 06 42	19,05	1894	2 x 2	15,3	2,46	5,95	12,6	10,6	40 000	44 000	0,88
AL 644	140 02 73	19,05	1894	4 x 4	15,3	2,46	5,95	22,4	20,4	80 000	88 000	1,73
AL 666	140 02 85	19,05	1894	6 x 6	15,3	2,46	5,95	32,3	30,3	120 000	137 000	2,57
AL 822	140 06 43	25,40	2525	2 x 2	20,2	3,06	7,93	15,6	12,6	70 000	78 000	1,45
AL 844	140 02 10	25,40	2525	4 x 4	20,2	3,06	7,93	28,2	25,2	145 000	156 000	2,84
AL 866	140 02 62	25,40	2525	6 x 6	20,2	3,06	7,93	40,8	37,8	200 000	230 000	4,24
AL 1044	140 02 86	31,75	3165	4 x 4	25,3	4,02	9,53	36,7	33,2	200 000	234 000	4,68
AL 1066	140 02 63	31,75	3165	6 x 6	25,3	4,02	9,53	53,2	49,7	300 000	336 000	6,99
AL 1244	140 02 87	38,10	3808	4 x 4	30,7	4,88	11,10	43,4	39,6	245 000	310 000	6,65
AL 1266	140 02 69	38,10	3808	6 x 6	30,7	4,88	11,10	63,5	59,4	368 000	470 000	9,94

Norma zakładowa

922	140 00 11	9,525	944	2 x 2	8,7	1,04	3,28	6,2	4,4	10 000	10 700	0,23
966	140 00 17	9,525	944	6 x 6	8,7	1,04	3,28	14,9	13,0	31 000	33 100	0,66
1222	140 00 21	12,70	1259	2 x 2	10,7	1,69	4,45	8,9	7,0	21 000	22 500	0,44
1244	140 00 24	12,70	1259	4 x 4	10,7	1,69	4,45	15,9</				



Powierzchnia przegubu dla łańcucha rolkowego i tulejkowego [cm²]

Podziałka	DIN 8187/ISO 606/BS 228			DIN 8154/ISO 1395/BS 228 DIN 8188/ISO 606/BS 228			DIN 8181/ISO 1275/BS 4687	
	jednorzędowe	dwurzędowe	trzyrzędowe	jednorzędowe	dwurzędowe	trzyrzędowe	Typ-B	Typ-A
5 mm	0,06							
6 mm	0,08	0,14						
1/4"				0,11	0,22	0,33		
8 mm	0,11	0,22	0,33					
3/8"	0,28	0,56	0,84	0,27	0,53	0,80		
1/2"	0,21 (081)							
1/2"	0,50	1,01	1,51	0,44	0,88	1,32		
5/8"	0,67	1,34	2,02	0,70	1,40	2,10		
3/4"	0,89	1,79	2,68	1,05	2,10	3,15		
1"	2,10	4,21	6,31	1,78	3,56	5,35	0,50	0,44
1 1/4"	2,96	5,91	8,87	2,61	5,22	7,83	0,67	0,70
1 1/2"	5,54	11,09	16,63	3,92	7,84	11,76	0,89	1,05
1 3/4"	7,39	14,79	22,18	4,70	9,40	14,10		
2"	8,10	16,21	24,31	6,42	12,84	19,26	2,10	1,78
2 1/2"	12,75	25,50	38,25	10,85	21,55	32,32	2,96	
3"	20,58	41,23	61,81				5,54	
3 1/2"	27,87	55,74	83,71				7,35	
4"	36,26	72,52	108,74				8,07	
4 1/2"	46,13	92,40	138,57					

Dopuszczalne obciążenie rolek dla prowadnic łańcuchowych z tworzywa i stali

DIN Nr	A&S Nr	p [mm]	F [N]		
			F [N]	F [N]	F [N]
-	1591	9,525	15	35	90
06 B-1	2191	9,525	20	50	140
-	1003	12,7	25	55	150
-	1602	12,7	30	70	180
08 B-1	1603	12,7	35	85	230
-	1622	15,875	30	80	200
10 B-1	1623	15,875	50	130	330
12 B-1	1642	19,05	75	190	480
16 B-1	1666	25,4	135	380	980
20 B-1	1682	31,75	180	530	1370
24 B-1	1702	38,1	290	950	2460

* temperatura otoczenia 23°C, max. przestój pod obciążeniem 96 godzin, max. prędkość obrotowa 1 m/s

Zdjęcia:

Przedstawiające w tym katalogu poszczególne typy produktów nie zawsze są idealnie zgodne, co do szczegółów z rzeczywistością.

Specyfikacje:

Arnold & Stolzenberg GmbH zachowuje prawo do zmian formy, wyglądu jak i wymiarów, aby odpowiadały one aktualnemu procesowi produkcyjnemu, stopniowi rozwoju technologicznego, co do materiałów jak i wyglądu wytwarzanych wyrobów.

Gwarancja:

Podstawowym wymogiem jest przestrzeganie naszych przepisów obsługowych i serwisowych. Pod żadnym pozorem łańcuchy nie mogą być przedłużane lub wymontowywane pojedyncze elementy, ponieważ prowadzi to do utraty odpowiednich certyfikatów jakości i ma wpływ na udzielaną gwarancję.

Przedruk:

Powielanie tego katalogu, przedruk jego fragmentów lub całości w jakiegokolwiek formie jest możliwy tylko za pisemną zgodą firmy Arnold & Stolzenberg GmbH. Za błędy powstałe podczas wydruku tego katalogu nie ponosimy żadnej odpowiedzialności.